

SONY

TC640A

---

MODEL

---

SERVICE MANUAL

---

## SECTION 3 ADJUSTMENTS

### 3-1. MECHANICAL ADJUSTMENTS

#### Pinch Roller Pressure Adjustment

— playback mode —

##### Pressure adjustment:

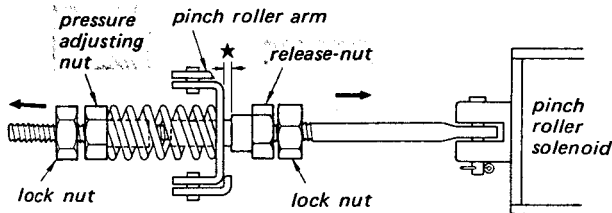

1. Melt locking compound on lock nuts with solvent.
2. Loosen lock nuts.
3. Loosen pressure adjusting nut and release-nut in the respective directions shown by arrows.
4. Place unit in playback mode.
5. Ensure that the solenoid is completely energized.
6. Adjust pressure adjusting nut for 2.2 kg (4 lb 13 oz) pressure.
7. Adjust release nut for 0.2 – 0.3 mm (10 mil) clearance shown by ★.
8. Ensure that the solenoid is completely energized with 2.2 kg (4 lb 13 oz) pinch roller pressure.
9. Tighten lock nuts and apply locking compound to the nuts.

**Note:** Use open-end wrench for turning nut.

##### Pressure measurement:

1. Remove pinch roller cap.  
(Refer to pinch roller removal on page 14).
2. Attach screw to pinch roller shaft as shown.

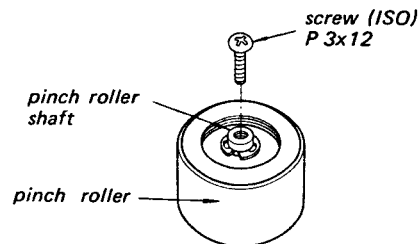

3.

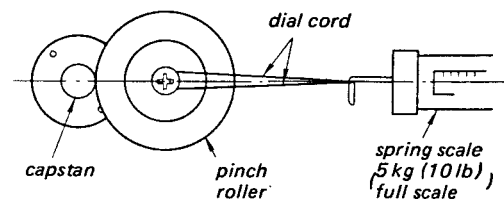

Pulling spring scale, read the scale reading just when pinch roller stops rotating.  
specification: 2.2 ± 0.2 kg  
(4 lb 13 oz ± 7 oz)

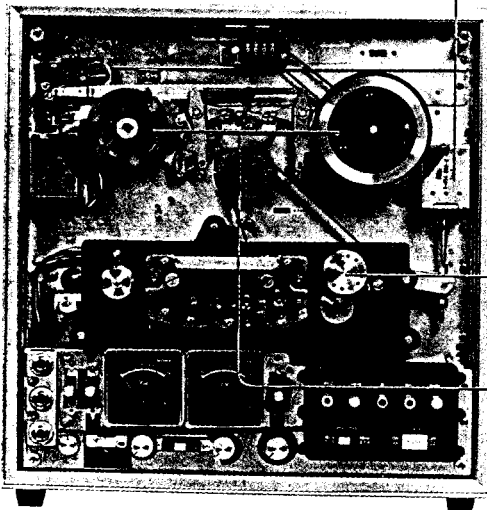

#### Reel Table Adjustment

— playback and rewind modes —

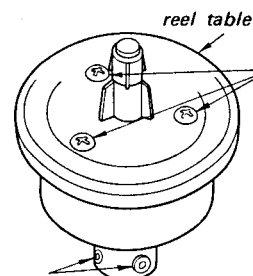

Loosen these screws and adjust reel table position so that reel table is concentric with reel shaft.

Loosen these set screws and adjust reel table height so that tape is wound at center between reel flanges.  
**Note:** Use hex-key wrench.

**Brake Torque Measurement**

— stop mode —

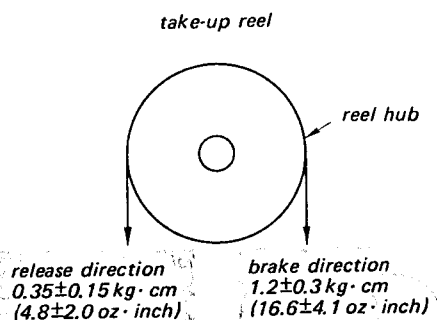
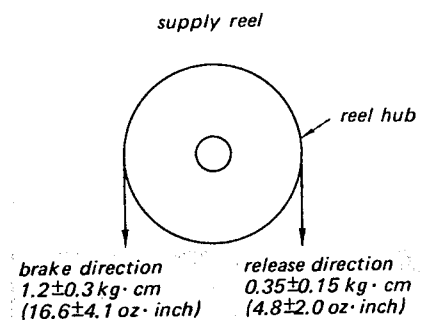

Note: When measuring torque, pull spring scale at 9.5 – 19 cm/s (3 3/4 – 7 1/2 ips) speed.

release direction torque: check only  
brake direction torque: Adjust as follows:

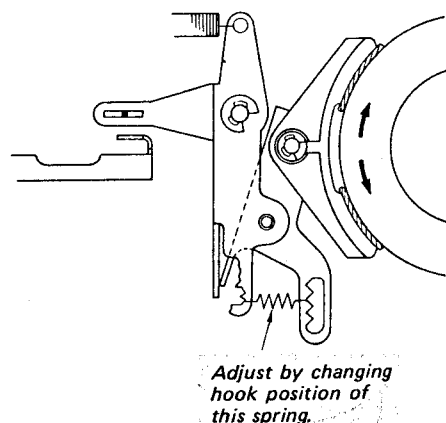

**Brake Adjustment**

— stop mode —

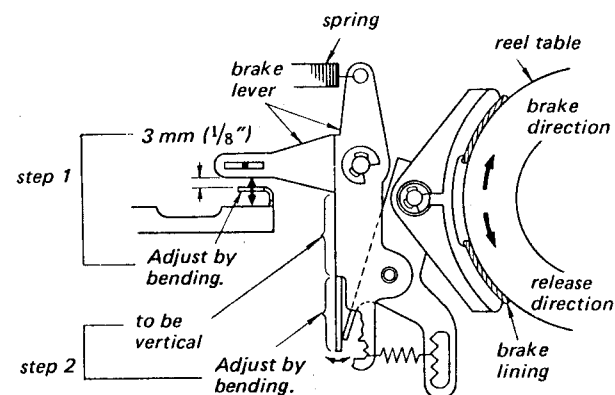

Note: 1. Adjust as specified when turning reel table in release direction.  
2. When turning reel table one turn in release direction, brake lever lower tip (adjusting portion) movement should be within 2 mm (5/64"). If the movement is more than 2 mm (5/64"), reel table or brake lining is defective.

**Head Height Adjustment**

— playback mode —

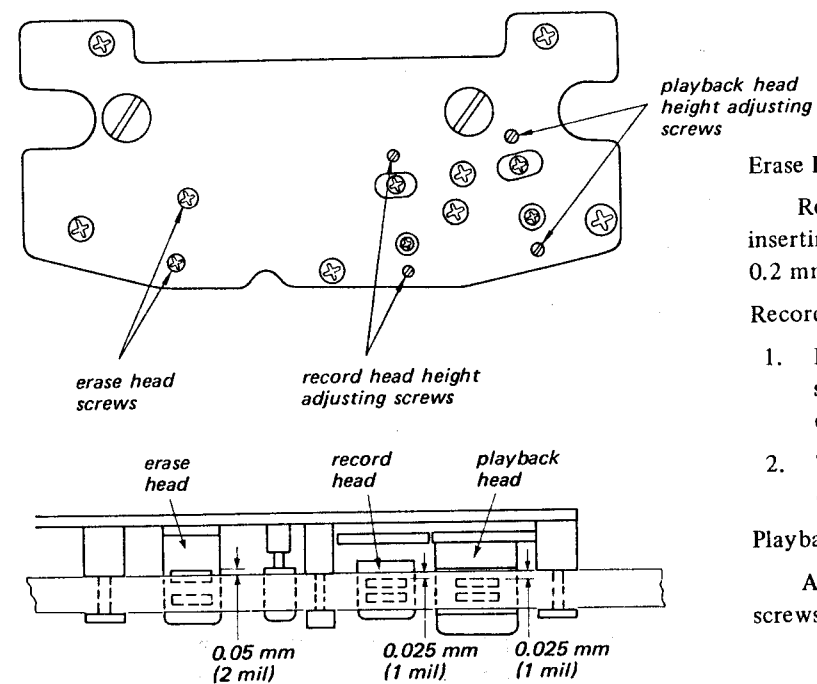

**Erase Head:**

Remove erase head screws and adjust by inserting spacer (part No. 3-141-020-02, ..... 0.2 mm t, 8 mil t)

**Record head;**

1. By turning record head height adjusting screws, align upper edge of record head core at upper edge of tape.
2. Turn the height adjusting screws 12 degrees clockwise.

**Playback Head:**

Adjust playback head height adjusting screws in the same way as record head.

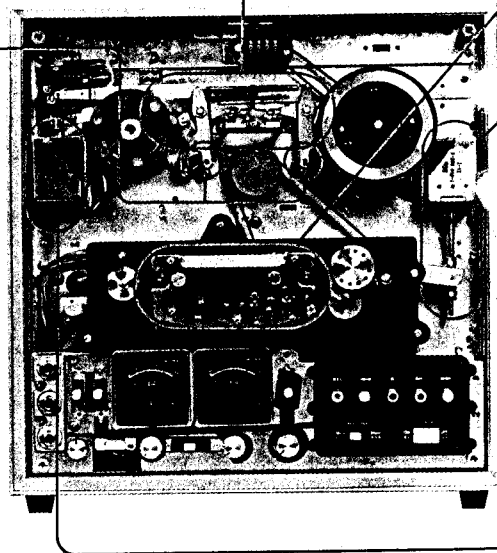

**Brake Arm Adjustment**

— stop mode —

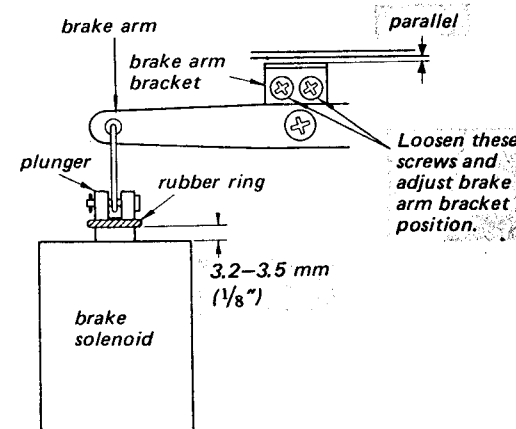

**Pinch Roller Solenoid Check**

power supply voltage: 90% of rated voltage

1. Hold pinch roller by hand and place unit in playback mode.
2. Permit pinch roller to slowly approach capstan.
3. Push plunger by finger and ensure that plunger is completely inserted in solenoid.

Note: If necessary, adjust pinch roller pressure.

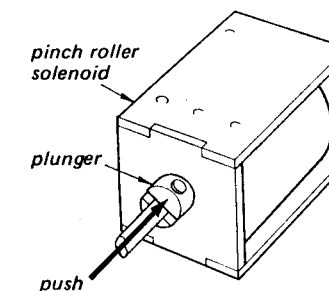

**Timing Lever Adjustment**  
— stop mode —

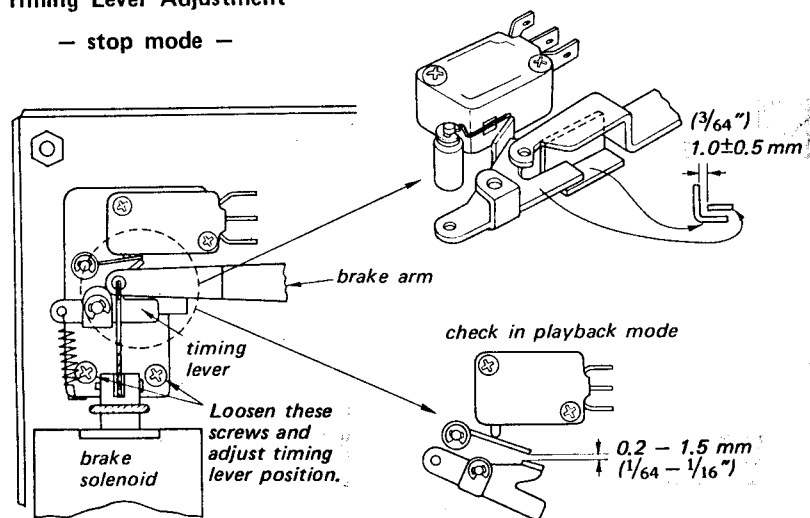

**Shut-off Switch Actuator Adjustment**  
— playback mode —

**Note:** 1. With head deck assembly removed, perform this adjustment. (Refer to scrape filter roller position adjustment on page 14.)  
2. After head deck assembly is installed, perform tape path adjustments on pages 13 and 14.

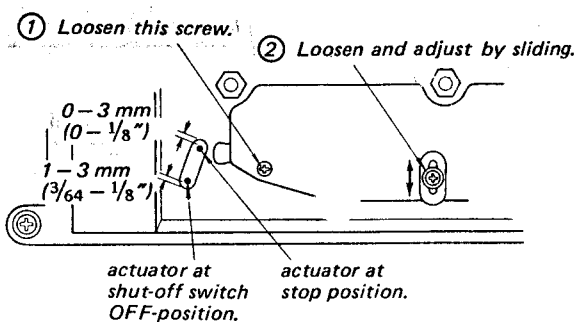

**Scrape Filter Roller Position Adjustment**  
— playback mode —

When tape does not turn scrape filter roller, perform this adjustment.

1. Remove head deck screws.
2. Remove head deck assembly.
3. Loosen roller fixing screw and position the roller forwards.
4. Fix roller fixing screw and install head deck assembly.
5. Perform Tape Path Adjustments.

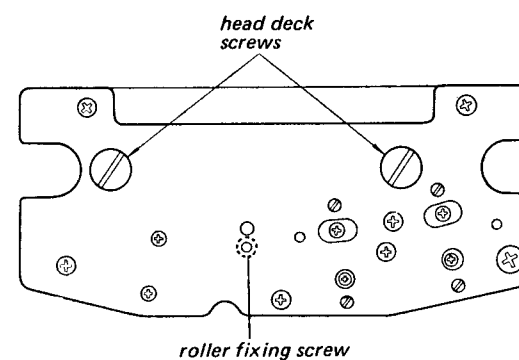

**Pinch Roller Removal**

1. Remove pinch roller cap with supplied tool.

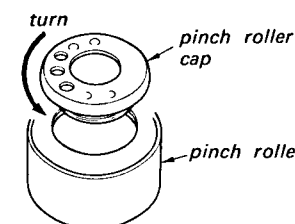

2. Remove retaining ring.

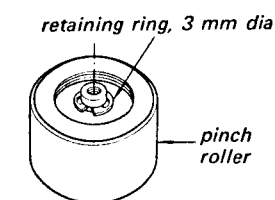

**Pinch Roller Adjustment**

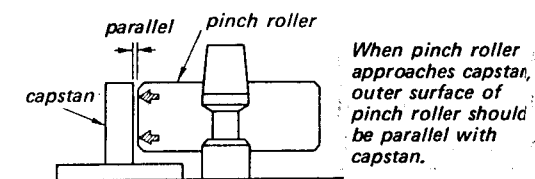

If necessary, with pinch roller removed, carefully adjust by bending pinch roller shaft as shown below.

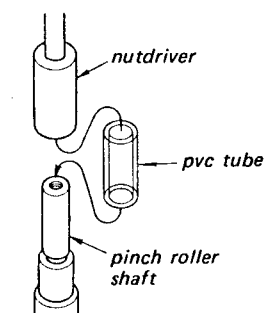

**Guide Roller Height Adjustment**

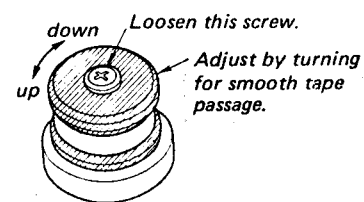

**TAPE PATH ADJUSTMENTS**

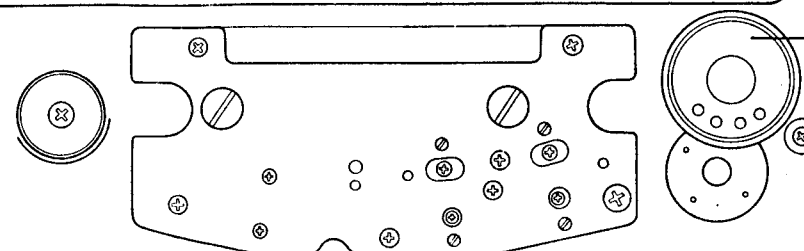
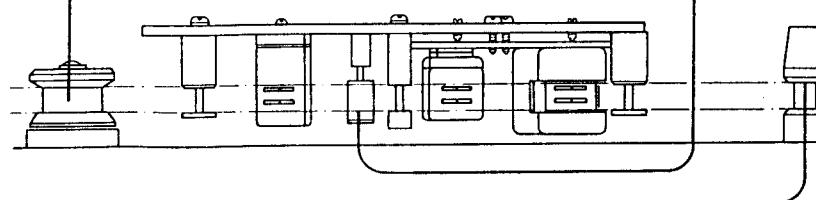

**Tape Guide (E) Adjustment**

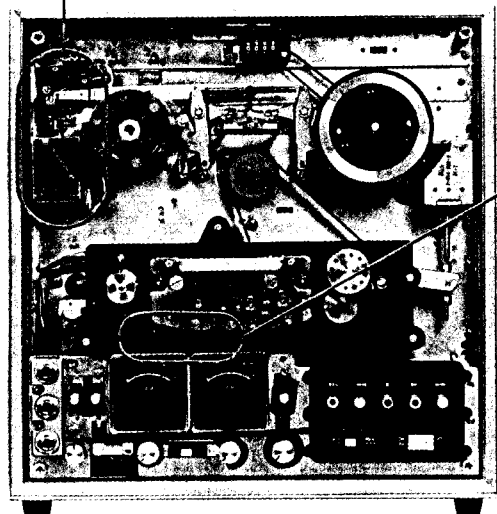
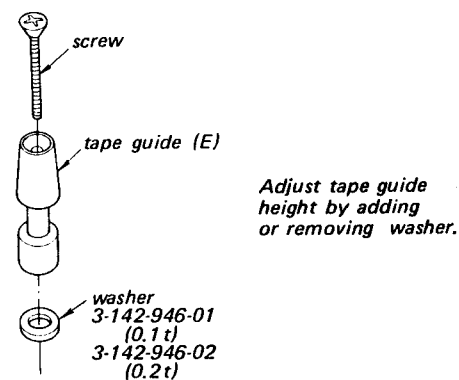

Sony

**Tape Slack Check**

— playback mode —

This check is available for timer operation.

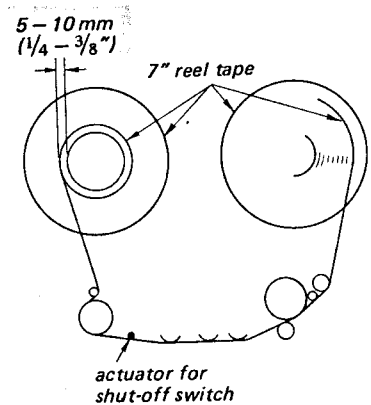

**Note:** Perform this check at 19 cm/s (7½ ips) tape speed in vertical operation.

1. After three-second playback operation, turn POWER switch OFF.
2. Ensure that shut-off switch is not actuated by tape slack.
3. Turn POWER switch ON.
4. Ensure that tape starts to run.
5. Repeat steps 1 to 4 a few times.

**Note:** If necessary, perform brake adjustment on page 11 or shut-off switch actuator adjustment on page 13.

**Capstan Lengthwise Play Adjustment**

— stop mode with power switch OFF —

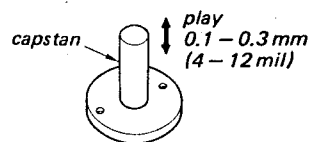

If necessary, adjust as follows:

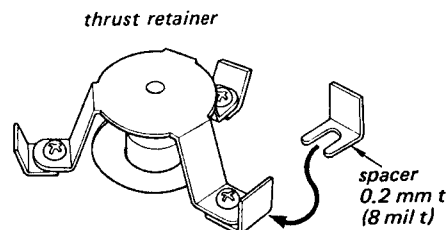

- Note:**
1. The same pieces of spacer is inserted respectively.
  2. If the play is more than 0.3 mm (12 mil) with spacers removed, the play up to 0.5 mm (20 mil) is allowable.

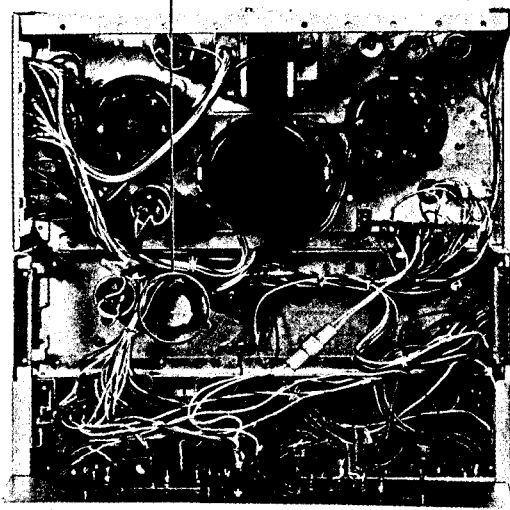

**Reel Motor Torque Measurements**

— playback mode —

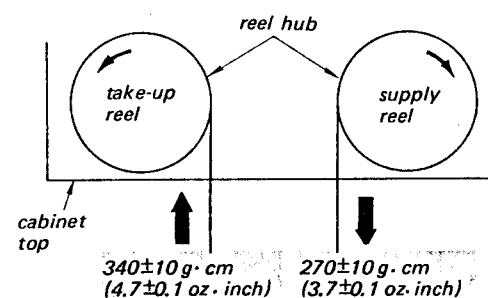

**Note:** When measuring torque, move spring scale in arrow direction at 9.5 – 19 cm/s (3¾ – 7½ ips).

If necessary, adjust  
R801 for take-up torque  
R802 for supply torque

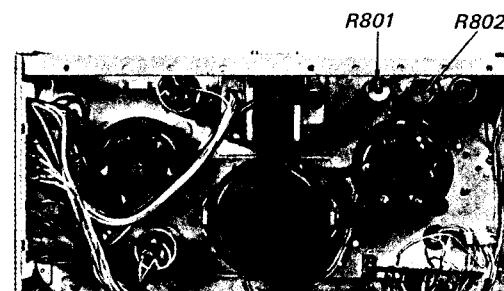

**CAUTION**

After adjustment, ensure that lead wires do not touch wirewound resistors. Wirewound resistors are heated during operation.

— fast forward mode —

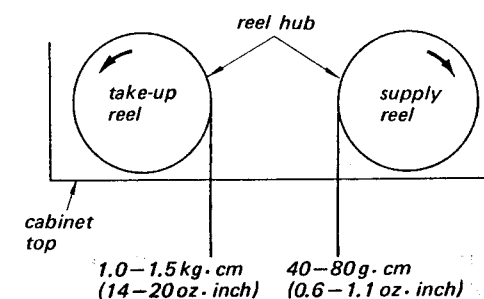

**Note:** Measure torque with spring scale stopped.

— rewind mode —

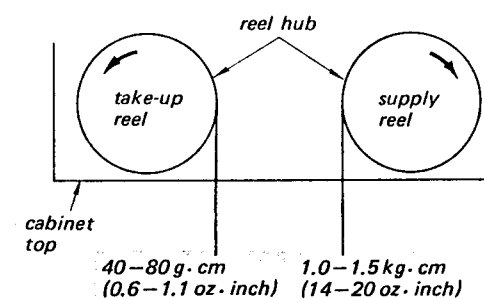

**Note:** Measure torque with spring scale stopped.

**3-2. ELECTRICAL ADJUSTMENTS AND MEASUREMENTS**

**PRECAUTION**

1. Clean the following parts with an alcohol moistened swab:
  - record head
  - playback head
  - erase head
  - capstan
  - pinch roller
  - rubber belts
  - idlers
2. Demagnetize record and playback heads with a head demagnetizer. (Don't use magnetized screwdriver for adjustments).
3. After the adjustments, apply locking compound to the parts adjusted.
4. Adjustments should be performed in the order arranged in this service manual.
5. Adjustments and measurements should be performed each channel with rated voltage unless otherwise specified.
6. The adjustments and measurements require the test equipment as follows:
  - \*VOM (20 kΩ/V)
  - \*VTVM
  - \*audio oscillator (af osc)
  - \*attenuator (600Ω)
  - \*oscilloscope
  - \*bandpass filter (1 kHz, 400 Hz)
  - \*blank tapes NPS-1 (NORMAL)  
SLH-S1 (SPECIAL)

\*digital frequency counter

\*wow meter

\*distortion meter

\*SONY test tapes

tape	tone						
	1	2	3	4	5	6	7
J-9-F1 (Hz)	5k	400	400	5k	3k	200	80
(dB)	-10	0	-10	-10	-10	-10	-10
J-19-F2 (Hz)	400	400	10k	12.5k	7k	80	40
(dB)	0	-10	-10	-10	-10	-10	-10

SPC-47 (4000 Hz, 19 cm/s (7½ ips)  
2000 Hz, 9.5 cm/s (3¾ ips)

WS-19-7 (3000 Hz, 19 cm/s, 7½ ips)

WS-9-7 (3000 Hz, 9.5 cm/s, 3¾ ips)

7. Rated input and output levels are as follows:

normal input level (1 kHz)

	MICROPHONE	LINE INPUT
impedance	300Ω	10 kΩ
level	-60dB (0.78mV)	-10dB (0.25V)

normal output level (1 kHz)

	LINE OUTPUT	HEADPHONE
load resistor	100kΩ	8 Ω
level	0dB (0.78V)	-22dB (62mV)

8. Use rated power voltage for adjustments and measurements.

**1. Power Supply Voltage Adjustment**

Control/Switch Setting:

no signal input

Procedure:

1.

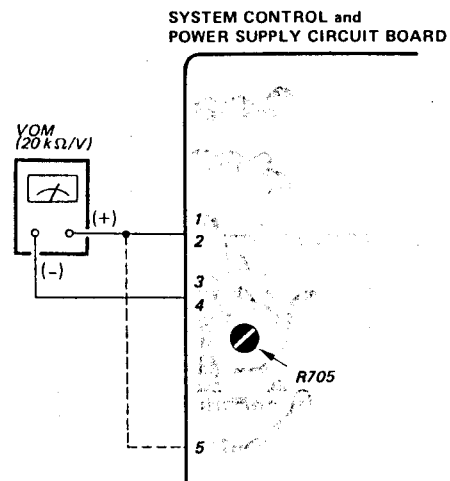

terminal	Adjust	VOM reading
1, 2	R705	26.5~27.5V

terminal	Check	VOM reading
5		23~25V

Adjustment Location:

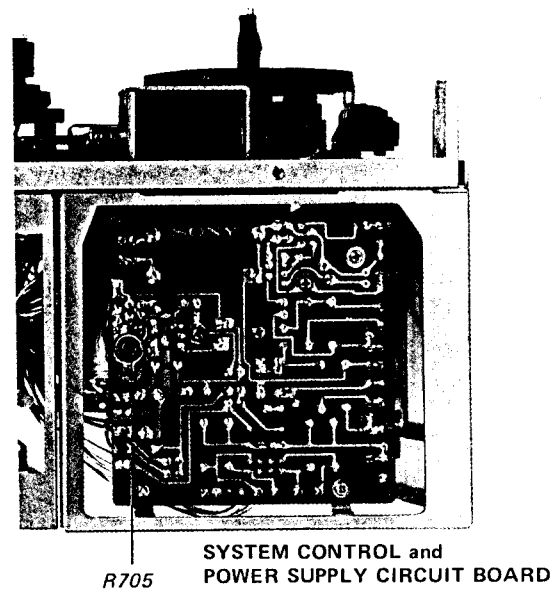

**2. Tape Speed Measurement**

Control/Switch Setting:

MONITOR switch ..... TAPE  
 TAPE SPEED switch .... 19 cm/s (7½ ips)  
 LINE OUT VOL ..... MAX

Procedure:

1. Mode: playback

SPC-47  
 (4000 Hz 19 cm/s)  
 (2000 Hz 9.5 cm/s)

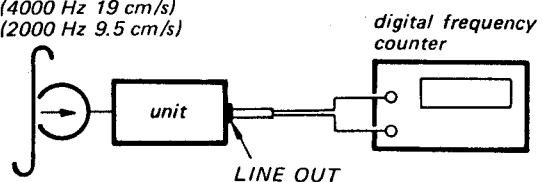

Specification:

3,960~4,040 Hz (19 cm/s, 7½ ips)  
 1,980~2,020 Hz (9.5 cm/s, 3¾ ips)

Note: 1. Measure beginning and end of tape.  
 2. Measurement should be done in ten second after tape starts to run. Measure three times and take average of them.

**3. Playback Head Angle Adjustment**

Control/Switch Setting:

MONITOR switch ..... TAPE  
 TAPE SELECT switch ... NORMAL  
 TAPE SPEED switch ... 19 cm/s (7½ ips)  
 LINE OUT VOL ..... MAX

Procedure:

1. Mode: playback

J-19-F2  
 3rd tone (10 kHz)

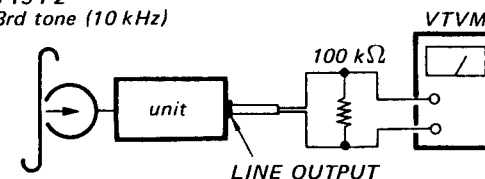

Adjust	VTVM reading
angle adjusting screws	maximum

Adjustment Location:

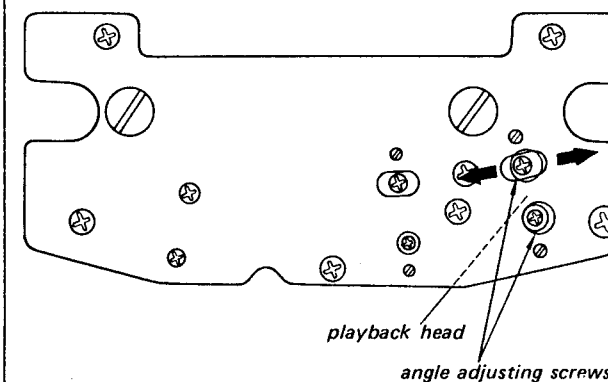

**4. Playback Head Azimuth Adjustment**

Control/Switch Setting:

MONITOR switch ..... TAPE  
 TAPE SPEED switch ..... 19 cm/s (7½ ips)  
 LINE OUT VOL ..... MAX

Procedure:

1. Mode: playback

J-19-F2  
 4th tone (12.5 kHz)

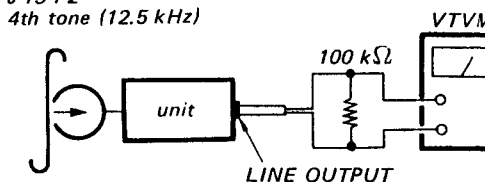

Adjust	VTVM reading	Remarks
azimuth adjusting screw	biggest peak	If the azimuth angles of L-CH and R-CH are not the same, set the screw midway between two screw positions.

Note: 1. If peak level difference between L-CH and R-CH is more than 1 dB, replace playback head.  
 2. When lightly touching supply reel by finger, ensure that output level does not increase more than 1 dB.

Adjustment Location:

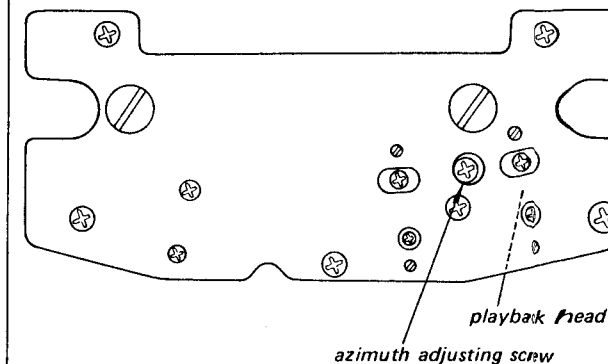

**5. Playback Phase Check**

**Control/Switch Setting:**

MONITOR switch ..... TAPE  
 TAPE SPEED switch ..... 19 cm/s (7½ ips)  
 LINE OUT VOL ..... MAX

**Procedure:**

1. Mode: playback

- (1) J-19-F2 2nd tone (400 Hz)
- (2) J-19-F2 3rd tone (10 kHz)

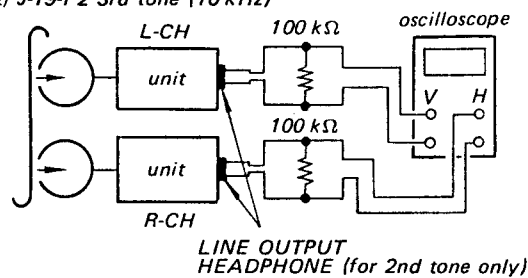

2.

Adjust	On the oscilloscope	
azimuth adjusting screw	(1) J-19-F2 2nd tone (400Hz) (both LINE OUTPUT and HEADPHONE)	(2) J-19-F2 3rd tone (10kHz) (LINE OUTPUT only)
	in phase	in phase     90° max
Note: If necessary, perform playback head angle and azimuth adjustment (On page 19).		

**6. Playback Level Adjustment and VU Meter Calibration**

**Control/Switch Setting:**

MONITOR switch ..... TAPE  
 TAPE SELECT switch ... NORMAL  
 TAPE SPEED switch ..... 19 cm/s (7½ ips)  
 LINE OUT VOL ..... MAX

**Procedure:**

1. Mode: playback

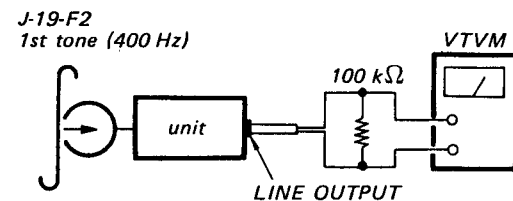

2.

	Adjust	VTVM reading	VU meter reading
Playback Level Adjustment	R414 (L-CH) R514 (R-CH)	0dB (0.78V)	—
VU meter calibration	R428 (L-CH) R528 (R-CH)	—	0 VU

- Note:** 1. Allowance: within ±1 dB.  
 2. Level difference between L-CH and R-CH: within 1 dB.

**Adjustment Location:**

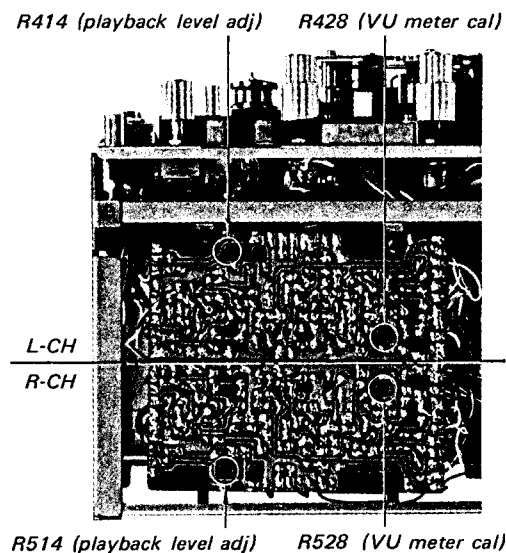

**7. Playback Frequency Response Adjustment (19 cm/s, 7½ ips)**

**Control/Switch Setting:**

MONITOR switch .....TAPE  
 TAPE SPEED switch .....19 cm/s (7½ ips)  
 LINE OUT VOL .....MAX

**Procedure:**

1. Mode: playback

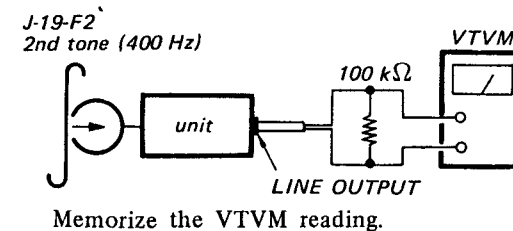

Memorize the VTVM reading.

2. Mode: playback

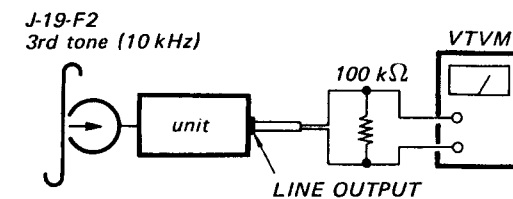

Adjust	VTVM reading
R412 (L-CH) R512 (R-CH)	the same value as in step 1

3. Play back test tape J-19-F2 and ensure that each tone output level deviation against 2nd tone is as follows.

J-19-F2	Tone	4	5	6	7
	Frequency (Hz)	12.5k	7k	80	40
Level Deviation from 2nd tone (400 Hz)	L-CH	0±2dB	0±2dB	+1.5±1.5dB	+1.5±2dB
	R-CH				

**Adjustment Location:**

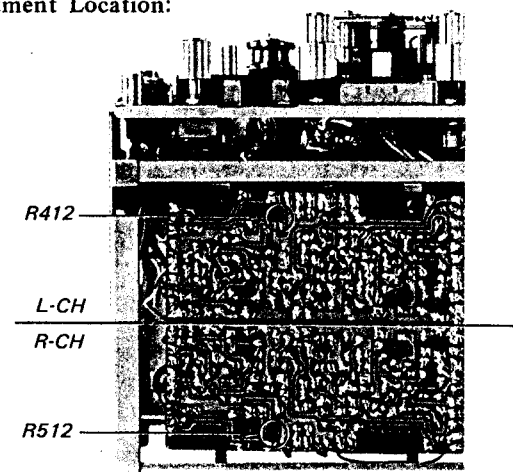

**8. Playback Frequency Response Measurement (9.5 cm/s, 3¾ ips)**

**Control/Switch Setting:**

MONITOR switch .....TAPE  
 TAPE SPEED switch .....9.5 cm/s (3¾ ips)  
 LINE OUT VOL .....MAX

**Procedure:**

1. Mode: playback

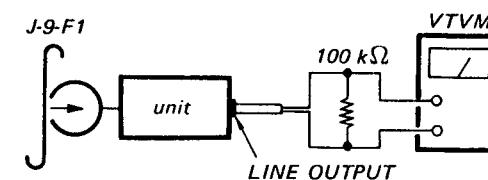

Ensure that each tone output level deviation against 3rd tone is as follows:

tone frequency	3rd 400 Hz	4th 5k	5th 3k	6th 200	7th 80
level difference for reference		+1.5±2dB	+1.5±1.5dB	+0.5±0.5dB	+1±dB



**9. Playback Signal-to-Noise Ratio Measurement**

**Control/Switch Setting:**

- MONITOR switch ..... TAPE
- TAPE SPEED switch ..... 19 cm/s (7½ ips)
- LINE OUT VOL ..... MAX

**Procedure:**

1. Mode: playback

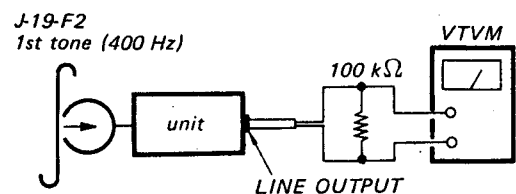

Memorize the VTVM reading.

2. Mode: playback with no tape threaded

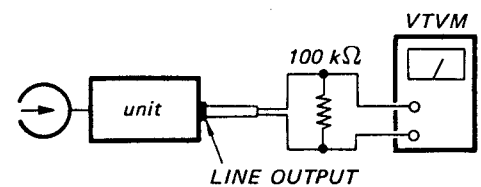

**Specification:**

greater than 48 dB  
(take the lower value when changing AC power cord connection)

**10. Minimum Input Level Measurement**

**Control/Switch Setting:**

- MONITOR switch ..... SOURCE
- TAPE SELECT switch ... NORMAL
- REC MODE switch ..... ON
- MIC ATT switch ..... OFF
- TAPE SPEED switch ..... 19 cm/s (7½ ips)
- LINE OUT VOL ..... MAX
- MIC REC VOL ..... MAX
- LINE IN REC VOL ..... MAX

**Procedure:**

1. Mode: record  
1 kHz, -72 dB (0.19 mV)

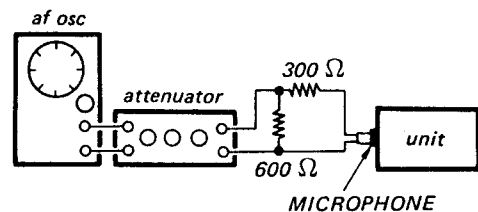

Ensure that VU meter reading is more than 0 VU.

2. Mode: record  
1 kHz, -22 dB (62 mV)

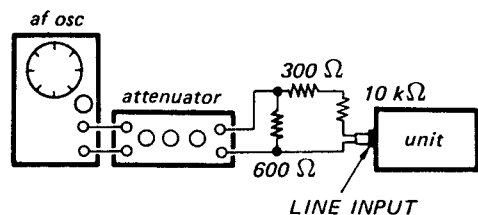

Ensure that VU meter reading is more than 0 VU.

**11. Input Level Variation Check**

**Control/Switch Setting:**

- MONITOR switch ..... SOURCE
- TAPE SELECT switch..... NORMAL
- REC MODE switch ..... ON
- MIC ATT switch ..... OFF
- TAPE SPEED switch ..... 19 cm/s (7½ ips)
- LINE OUT VOL ..... MAX
- MIC REC VOL ..... For 0 dB (0.78 V) LINE OUT level with 1 kHz, -60 dB (0.78 mV) MICROPHONE signal.
- LINE IN REC VOL ..... For 0 dB (0.78 V) LINE OUT level with 1 kHz, -10 dB (0.25 V) LINE IN signal.

**LINE IN REC VOL variation**

**Procedure:**

1. Mode: record  
1 kHz, -60 dB (0.78 mV)

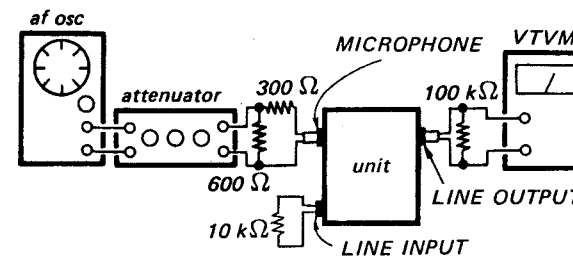

LINE IN REC VOL control	VTVM reading
MIN → MAX	less than 2 dB

**MIC REC VOL variation**

**Procedure:**

1. Mode: record  
1 kHz, -10 dB (0.25V)

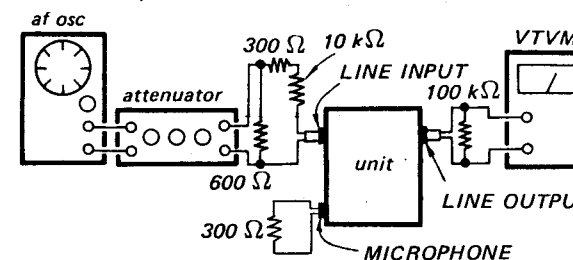

MIC REC VOL control	VTVM reading
MIN → MAX	less than 2 dB

**12. MIC ATT Switch Check**

**Control/Switch Setting:**

- MONITOR switch ..... SOURCE
- TAPE SELECT switch.... NORMAL
- REC MODE switch ..... ON
- MIC ATT switch ..... OFF
- TAPE SPEED switch..... 19 cm/s (7½ ips)
- LINE OUT VOL ..... MAX
- MIC REC VOL ..... For 0 dB (0.78 V) LINE OUT level with 1 kHz, -60 dB (0.78 mV) MICROPHONE signal.

**Procedure:**

1. Mode: record  
1 kHz, -60 dB (0.78 mV)

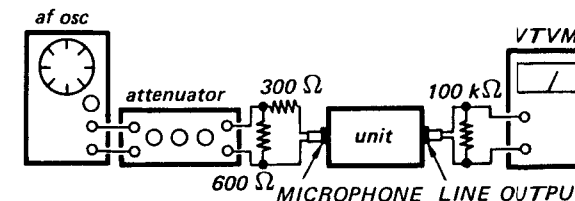

MIC ATT switch	level difference
OFF	for reference
1	-17 ~ -13 dB
2	-32 ~ -28 dB

**13. LINE OUT VOL Check**

**Control/Switch Setting:**

- MONITOR switch ..... SOURCE
- TAPE SELECT switch .... NORMAL
- REC MODE switch ..... ON
- MIC ATT switch ..... OFF
- TAPE SPEED switch ..... 19 cm/s (7½ ips)
- LINE OUT VOL ..... MAX
- MIC REC VOL ..... For 0 dB (0.78 V) LINE OUT level with 1 kHz, -60 dB (0.78 mV) MICROPHONE signal.

**Procedure:**

1. Mode: record  
1 kHz, -60 dB (0.78 mV)

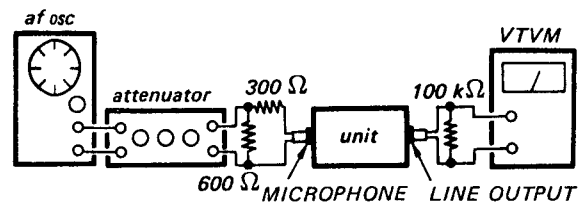

LINE OUT VOL control	level difference	VU meter
MAX	for reference	0 VU
MIN	-33~-27dB	0 VU

Note: When turning LINE OUT VOL control from MAX to MIN, ensure that VU meter reading does not change.

**14. Bias Trap Coil Adjustment**

**Control/Switch Setting:**

- TAPE SELECT switch .... NORMAL
- REC MODE switch ..... ON
- TAPE SPEED switch ..... 19 cm/s (7½ ips)

**Procedure:**

1. Mode: record

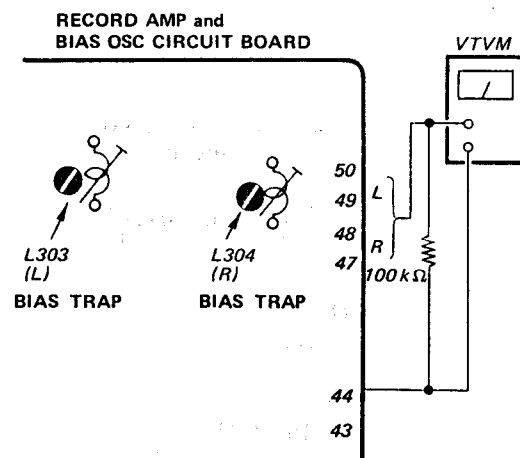

Adjust	VTVM reading
L303 (L-CH)	minimum
L304 (R-CH)	(less than -6 dB (0.38V))

**Adjustment Location:**

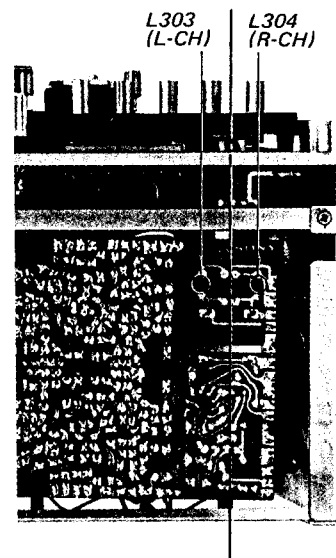

**15. Record Head Height Adjustment**

**Control/Switch Setting:**

- MONITOR switch ..... TAPE
- TAPE SELECT switch .... NORMAL
- REC MODE switch ..... ON
- MIC ATT switch ..... OFF
- TAPE SPEED switch ..... 19 cm/s (7½ ips)
- LINE OUT VOL ..... MAX
- LINE IN REC VOL ..... For 0 dB (0.78 V) LINE OUT level with 1 kHz, -10 dB (0.25 V) LINE IN signal.

**Procedure:**

1. Mode: record  
1 kHz, -10 dB (0.25V)

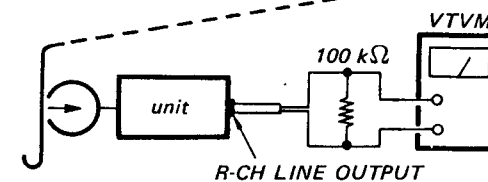
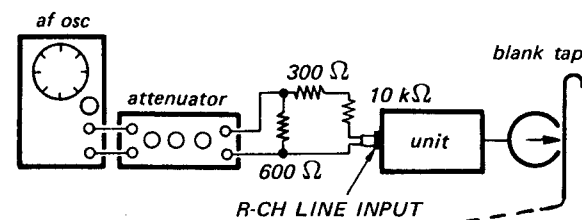

2.

Adjust	VTVM reading
record head height screws	maximum

Note: When performing this adjustment, the two screws should be turned in the same angle.

**Adjustment Location:**

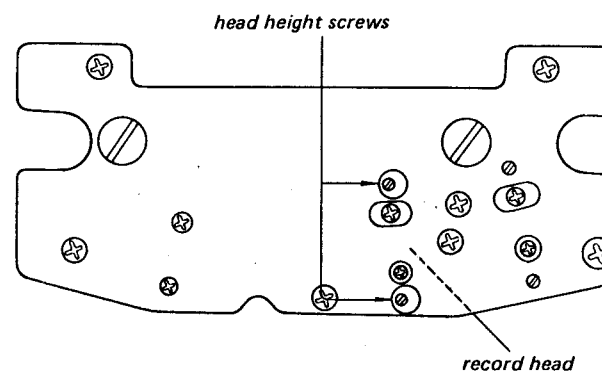

**16. Record Head Angle Adjustment**

**Control/Switch Setting:**

- MONITOR switch ..... TAPE
- TAPE SELECT switch .... NORMAL
- REC MODE switch ..... ON
- MIC ATT switch ..... OFF
- TAPE SPEED switch ..... 19 cm/s (7½ ips)
- LINE OUT VOL ..... MAX
- LINE IN REC VOL ..... For 0 dB (0.78 V) LINE OUT level with 1 kHz, -10 dB (0.25 V) LINE IN signal.

**Procedure:**

1. Mode: record  
10 kHz, -30 dB (24.5 mV)

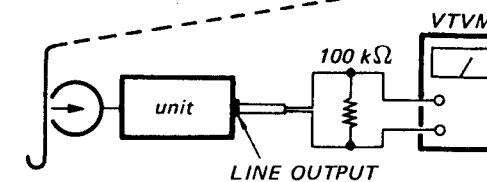
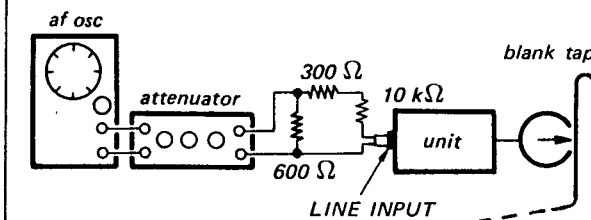

2.

Adjust	VTVM reading
angle adjusting screws	maximum

**Adjustment Location:**

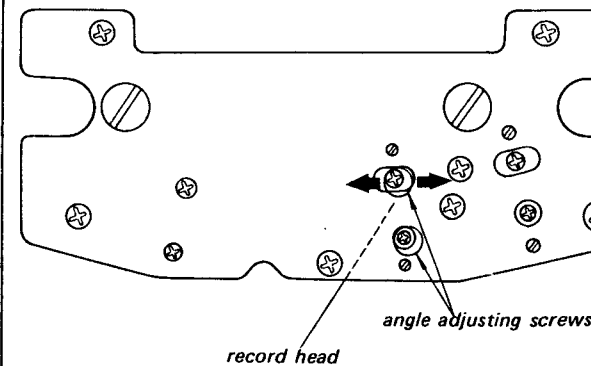

**17. Record Head Azimuth Adjustment**

**Control/Switch Setting:**

MONITOR switch ..... TAPE  
 TAPE SELECT switch .... NORMAL  
 REC MODE switch ..... ON  
 MIC ATT switch ..... OFF  
 TAPE SPEED switch ..... 19 cm/s (7½ ips)  
 LINE OUT VOL ..... MAX  
 LINE IN REC VOL ..... For 0 dB (0.78V)  
 (MONITOR switch: SOURCE) LINE OUT level  
 (LINE OUT VOL: MAX) with 1 kHz,  
 -10 dB (0.25V)  
 LINE IN signal.

**Procedure:**

1. Mode: record  
 15 kHz, -30 dB (24.5 mV)

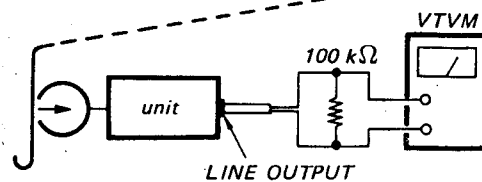
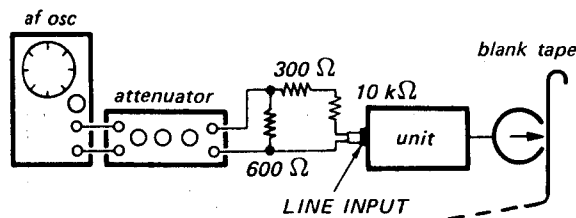

Adjust	VTVM reading	Remarks
azimuth adjusting screw	maximum	If the azimuth angles of L-CH and R-CH are not the same, set the screw midway between two screw positions.

**Note:** If peak level difference between L-CH and R-CH is more than 1 dB, replace record head.

**Adjustment Location:**

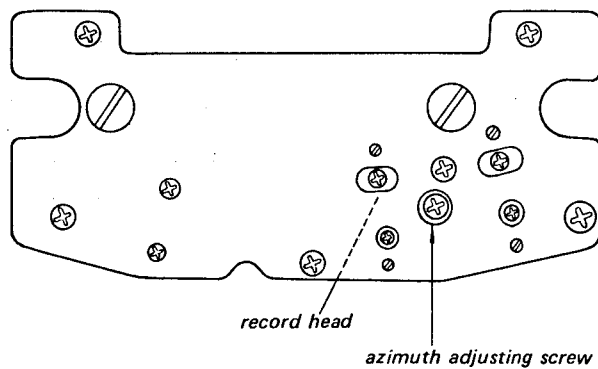

**18. Bias Adjustment**

**Control/Switch Setting:**

MONITOR switch ..... TAPE  
 TAPE SELECT switch .... NORMAL  
 REC MODE switch ..... ON  
 MIC ATT switch: ..... OFF  
 TAPE SPEED switch ..... 19 cm/s (7½ ips)  
 LINE OUT VOL ..... MAX  
 LINE IN REC VOL ..... For 0 dB (0.78V)  
 (MONITOR switch: SOURCE) LINE OUT level  
 (LINE OUT VOL: MAX) with 1 kHz,  
 -10 dB (0.25V)  
 LINE IN signal.

**Procedure:**

1. Mode: record  
 1 kHz, -10 dB (0.25V)

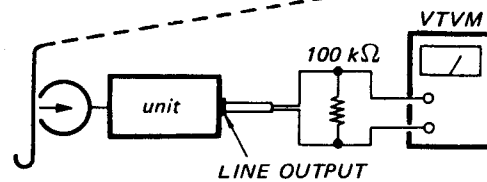
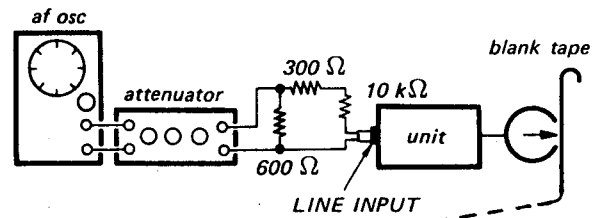

Adjust	VTVM reading
C308 (L-CH) C309 (R-CH)	0.5 dB below the maximum (Turn the capacitor counter-clockwise from the maximum output position)

**Adjustment Location:**

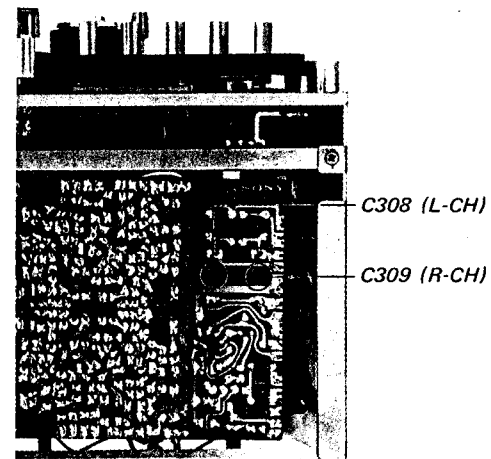

**19. Overall Phase Check**

**Control/Switch/Setting:**

MONITOR switch ..... TAPE  
 TAPE SELECT switch .... NORMAL  
 REC MODE switch ..... ON  
 MIC ATT switch ..... OFF  
 TAPE SPEED switch ..... 19 cm/s (7½ ips)  
 LINE OUT VOL ..... MAX  
 LINE IN REC VOL ..... For 0 dB (0.78V)  
 (MONITOR switch: SOURCE) LINE OUT level  
 (LINE OUT VOL: MAX) with 1 kHz,  
 -10 dB (0.25V)  
 LINE IN signal.

**Procedure:**

1. Mode: record  
 1~10 kHz, -30 dB (24.5 mV)

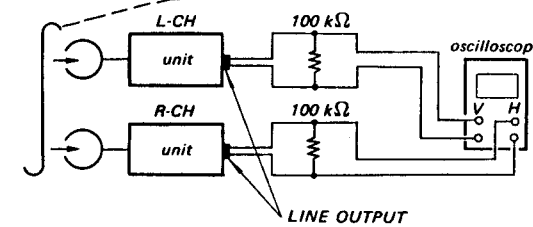
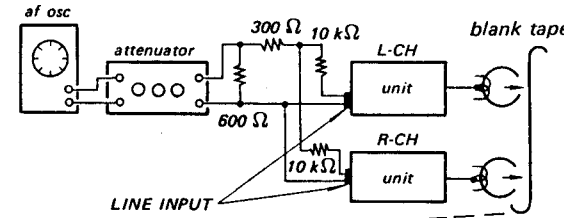

Measure	on the oscilloscope
1 kHz	in phase
↓	
10 kHz	in phase ~ 45° ~ 90°

**Note:** If phase difference between L-CH and R-CH is more than 90°, finely adjust the record head azimuth adjusting screw.

**20. Record Level Adjustment**

**Control/Switch Setting:**

MONITOR switch ..... TAPE  
 TAPE SELECT switch .... NORMAL  
 REC MODE switch ..... ON  
 MIC ATT switch ..... OFF  
 TAPE SPEED switch ..... 19 cm/s (7½ ips)  
 LINE OUT VOL ..... MAX  
 LINE IN REC VOL ..... For 0 dB (0.78V)  
 (MONITOR switch: SOURCE) LINE OUT level  
 (LINE OUT VOL: MAX) with 1 kHz,  
 -10 dB (0.25V)  
 LINE IN signal.

**Procedure:**

1. Mode: record  
 1 kHz, -10 dB (0.25V)

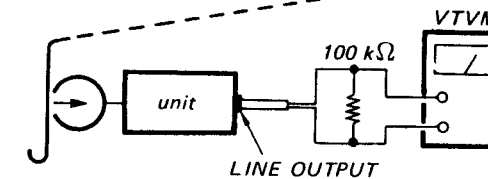
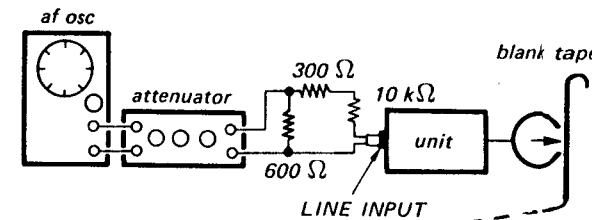

Adjust	VTVM reading
R124 (L-CH) R224 (R-CH)	0 dB (0.78V)

**Note:** allowance: within ±1 dB

**Check:**

Switch	VU meter reading
MONITOR switch: TAPE → SOURCE	within 2 dB difference
TAPE SPEED switch: 9.5 cm/s (3¾ ips)	within 2 dB between L-CH and R-CH
MONITOR switch: TAPE	

**Adjustment Location:**

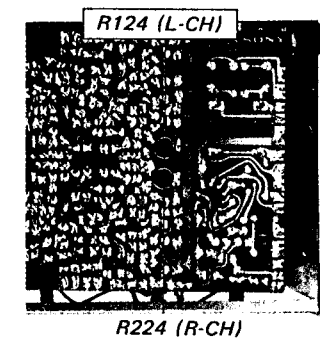

21. Dummy Coil Adjustment

Control/Switch Setting:

- MONITOR switch .....TAPE
- TAPE SELECT switch..... NORMAL
- REC MODE switch ..... ON (both channels)
- MIC ATT switch..... OFF
- TAPE SPEED switch ..... 19 cm/s (7½ ips)
- LINE OUT VOL ..... MAX
- LINE IN REC VOL ..... For 0 dB (0.78V)
- (MONITOR switch: SOURCE) LINE OUT level
- (LINE OUT VOL: MAX) with 1 kHz,
- 10 dB (0.25V)
- LINE IN signal.

Procedure:

- Mode: record  
20 kHz, -30 dB (24.5mV)

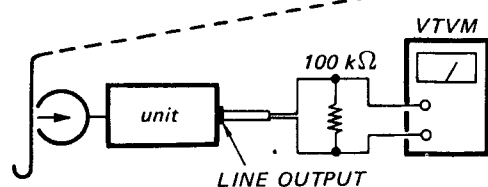
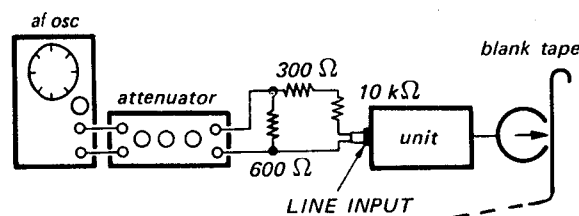

REC MODE switch: ON → OFF	Adjust	LINE OUTPUT	VTVM reading
L-CH	L305	R-CH	no change
R-CH	L306	L-CH	no change

Note: allowance: within ±2 dB

Adjustment Location:

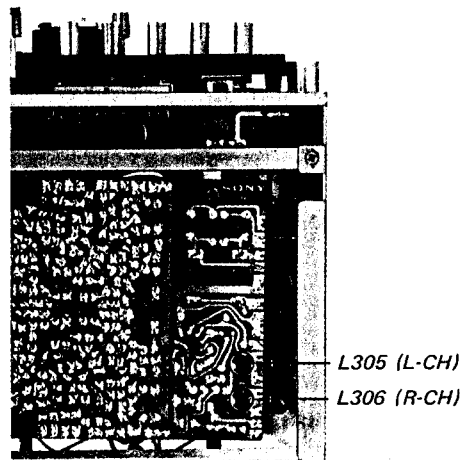

22. Overall Frequency Response Measurement

Control/Switch Setting:

- MONITOR switch ..... TAPE
- TAPE SELECT switch ..... NORMAL and SPECIAL
- REC MODE switch ..... OFF
- MIC ATT switch ..... OFF
- TAPE SPEED switch ..... 19 cm/s (7½ ips) and  
9.5 cm/s (3¾ ips)
- LINE OUT VOL ..... MAX
- LINE IN REC VOL ..... For 0 dB (0.78V)
- (MONITOR switch: SOURCE) LINE OUT level
- (LINE OUT VOL: MAX) with 1 kHz,
- 10 dB (0.25V)
- LINE IN signal.

Procedure:

- Mode: record  
1 kHz  
50 Hz  
100 Hz  
5 kHz  
7 kHz  
12.5 kHz  
20 kHz  
-30 dB (24.5 mV)

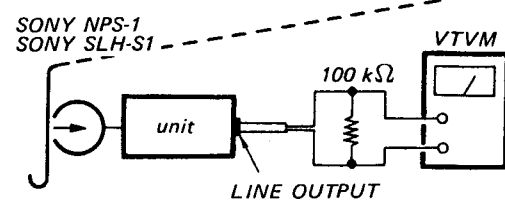
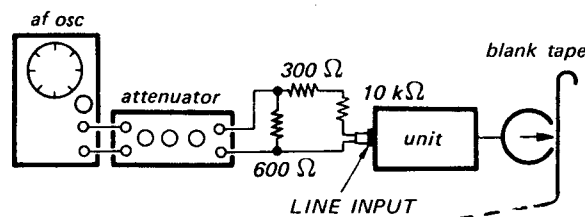

Specification:

Tape SPEED	NPS-1 (TAPE SELECT switch: NORMAL)		SLH-S1 (TAPE SELECT switch: SPECIAL)	
	19 cm/s	9.5 cm/s	19 cm/s	9.5 cm/s
1 kHz (for reference)	0 dB	0 dB	0 dB	0 dB
50 Hz	±3 dB	+3 -5 dB	±3 dB	+3 -6 dB
100 Hz	±3 dB	±3 dB	±3 dB	±3 dB
5 kHz	±3 dB	±3 dB	±3 dB	±3 dB
7 kHz	±3 dB	±3 dB	±3 dB	±3 dB
12.5 kHz	±3 dB	+3 -4 dB	±3 dB	±3 dB
20 kHz	+3 -4 dB	—	±3 dB	+3 -9 dB

23. Overall Signal-to-Noise Ratio Measurement

Control/Switch Setting:

- MONITOR switch ..... TAPE
- TAPE SELECT switch..... NORMAL and SPECIAL
- REC MODE switch ..... ON
- MIC ATT switch ..... OFF
- TAPE SPEED switch ..... 19 cm/s (7½ ips)
- LINE OUT VOL ..... MAX
- MIC REC VOL ..... For 0 dB (0.78V)
- (MONITOR switch: SOURCE) LINE OUT level
- (LINE OUT VOL: MAX) with 1 kHz,
- 60 dB (0.78 mV)
- MICROPHONE signal.

Procedure:

- Mode: record  
1 kHz, -60 dB (0.78 mV)

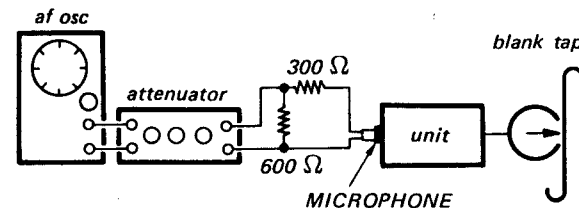

- Mode: record

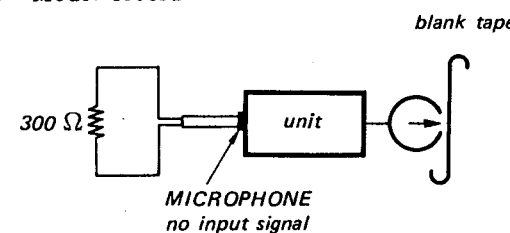

- Mode: playback

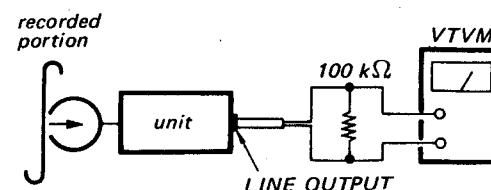

Recorded Signal	VTVM reading	
	NORMAL (NPS-1)	SPECIAL (SLH-S1)
1 kHz	0dB (0.78V)	0dB (0.78V)
no signal	less than -45dB (4.4mV)	less than -47dB (3.5mV)

24. Overall Distortion Measurement

Control/Switch Setting:

- MONITOR switch ..... TAPE
- TAPE SELECT switch ..... NORMAL
- REC MODE switch ..... ON
- MIC ATT switch ..... OFF
- TAPE SPEED switch ..... 19 cm/s (7½ ips)
- LINE OUT VOL ..... MAX
- MIC REC VOL ..... For 0 dB (0.78V)
- (MONITOR switch: SOURCE) LINE OUT level
- (LINE OUT VOL: MAX) with 1 kHz,
- 60 dB (0.78 mV)
- MICROPHONE signal.

Procedure:

- Mode: record  
1 kHz, -60 dB (0.78 mV)

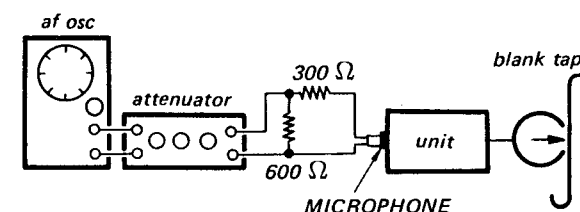

- Mode: playback

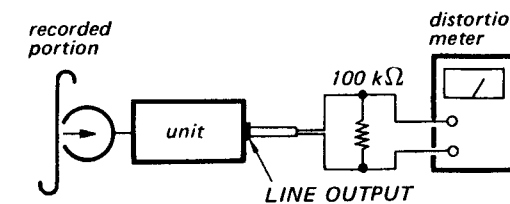

Specification: less than 1.5[%]

**25. Erase Ratio Measurement**

**Control/Switch Setting:**

- MONITOR switch ..... TAPE
- TAPE SELECT switch .... NORMAL
- REC MODE switch ..... ON
- MIC ATT switch ..... OFF
- TAPE SPEED switch ..... 19 cm/s (7½ ips)
- LINE OUT VOL ..... MAX
- MIC REC VOL ..... For 0 dB (0.78V)
- (MONITOR switch: SOURCE) LINE OUT level with 1 kHz, -60 dB (0.78 mV) MICROPHONE signal.
- (LINE OUT VOL: MAX)

**Procedure:**

1. Mode: record  
400 Hz, -50 dB (2.45 mV)

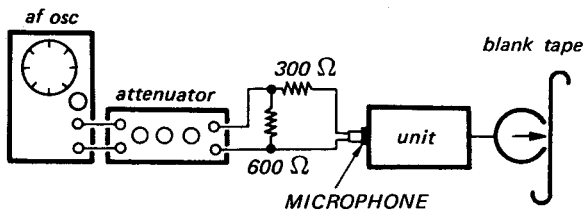

2. Rewind half of the recorded portion.
3. Mode: record (erase)

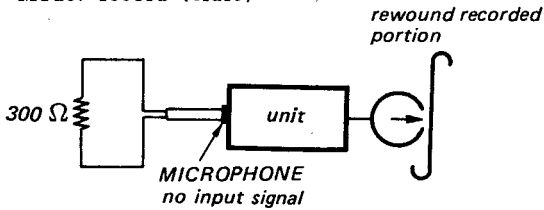

4. Mode: playback

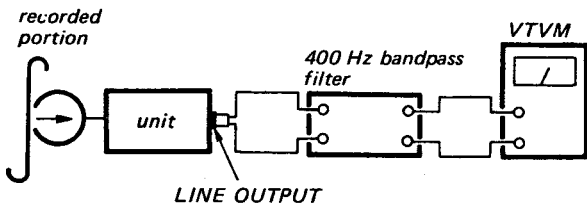

- Note:**
1. Use impedance-matching-free bandpass filter provided with buffer amplifier.
  2. When measuring without bandpass filter, compare unit (the same model) by hearing.

**Specification:**

Recorded Signal	VTVM reading
400 Hz	level difference
no signal	greater than 60 dB

**26. Cross-talk Measurement (between channels)**

**Control/Switch Setting:**

- MONITOR switch .....TAPE
- TAPE SELECT switch ....NORMAL
- REC MODE switch .....ON
- MIC ATT switch .....OFF
- TAPE SPEED switch .....19 cm/s (7½ ips)
- LINE OUT VOL .....MAX
- MIC REC VOL ..... For 0 dB (0.78V)
- (MONITOR switch: SOURCE) LINE OUT level with 1 kHz, -60 dB (0.78 mV) MICROPHONE signal.
- (LINE OUT VOL: MAX)

**Procedure:**

**L-CH → R-CH**

1. Mode: record  
1 kHz, -50 dB (2.45 mV)

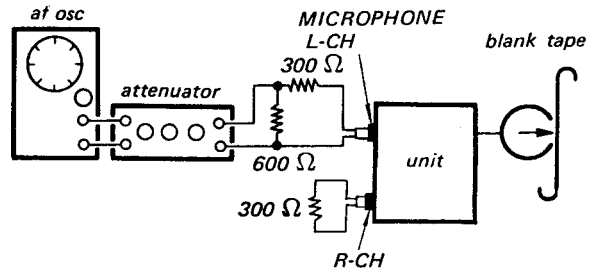

2. Mode: playback

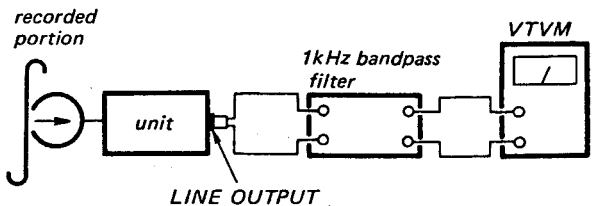

- Note:**
1. Use impedance-matching-free bandpass filter provided with buffer amplifier.
  2. When measuring without bandpass filter, compare with normal operating unit (the same model) by hearing.

LINE OUT	VTVM reading
L-CH	level difference
R-CH	greater than 48 dB

**R-CH → L-CH**

3. Terminate L-CH MICROPHONE jack with 300Ω resistor.
4. Supply 1 kHz, -50 dB (2.45 mV) signal to R-CH MICROPHONE jack.
5. Perform steps 1 and 2.

SECTION 4  
DIAGRAMS

27. Cross-talk Measurement (between tracks)

Control/Switch Setting:

- MONITOR switch ..... TAPE
- TAPE SELECT switch .... NORMAL
- REC MODE switch ..... ON
- MIC ATT switch ..... OFF
- TAPE SPEED switch ..... 19 cm/s (7½ ips)
- LINE OUT VOL ..... MAX
- MIC REC VOL ..... For 0 dB (0.78V)
- (MONITOR switch: SOURCE) LINE OUT level with 1 kHz, -60 dB (0.78 mV) MICROPHONE signal.

Procedure:

1. Mode: record
  - (1) 1 kHz, -50 dB (2.45 mV) both L-CH and R-CH MICROPHONE
  - (2) 1 kHz, -50 dB (2.45 mV) R-CH MICROPHONE only

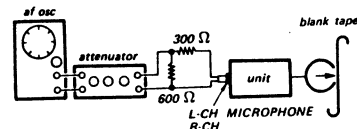

2. Mode: playback

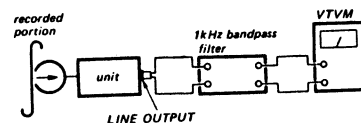

- Note:
1. Use impedance-matching-free bandpass filter provided with buffer amplifier.
  2. When measuring without bandpass filter, compare with normal operating unit (the same model) by hearing.

Memorize VTVM reading.

3. Reverse the tape reels.
4. Mode: playback adjacent track of recorded track

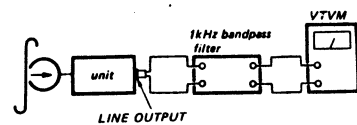

Playback	VTVM reading
(1) R-CH	level difference from reading in step 2: greater than 60 dB
(2) L-CH	

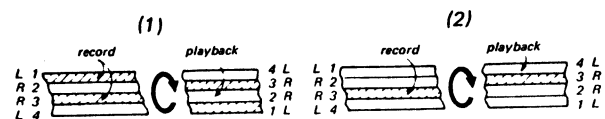

28. Wow and Flutter Measurement

Control/Switch Setting:

- MONITOR switch ..... TAPE
- TAPE SELECT switch .... NORMAL
- TAPE SPEED switch ..... 19 cm/s (7½ ips) and 9.5 cm/s (3¾ ips)
- LINE OUT VOL ..... MAX

Move tension arm in the direction shown by the arrow.

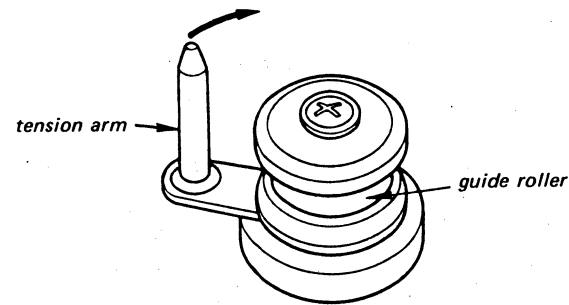

Procedure:

Note: Measure wow and flutter for beginning and end portion of tape.

1. at 7½ ips (19 cm/s)  
Mode: playback

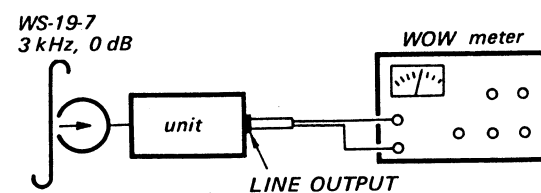

Specification:  
less than 0.11% (RMS)  
less than 0.07% (RMS) weighted

2. at 3¾ ips (9.5 cm/s)  
Mode: playback

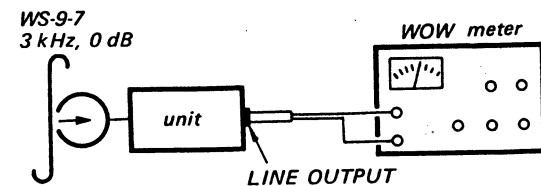

Specification:  
less than 0.17% (RMS)  
less than 0.11% (RMS) weighted

4-1. LEVEL DIAGRAM

Playback

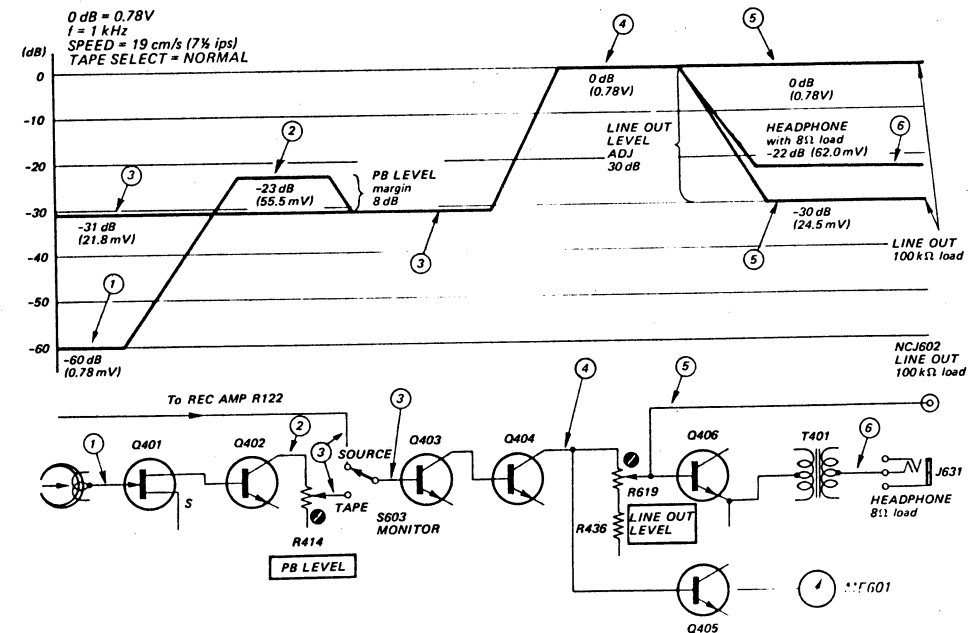

Record

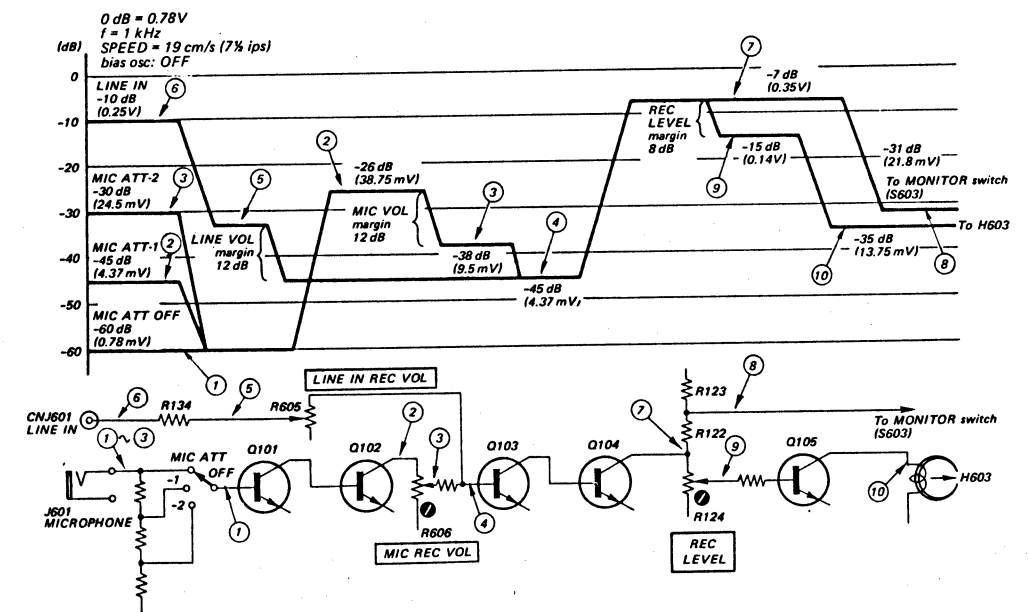

4-2. SCHEMATIC DIAGRAM

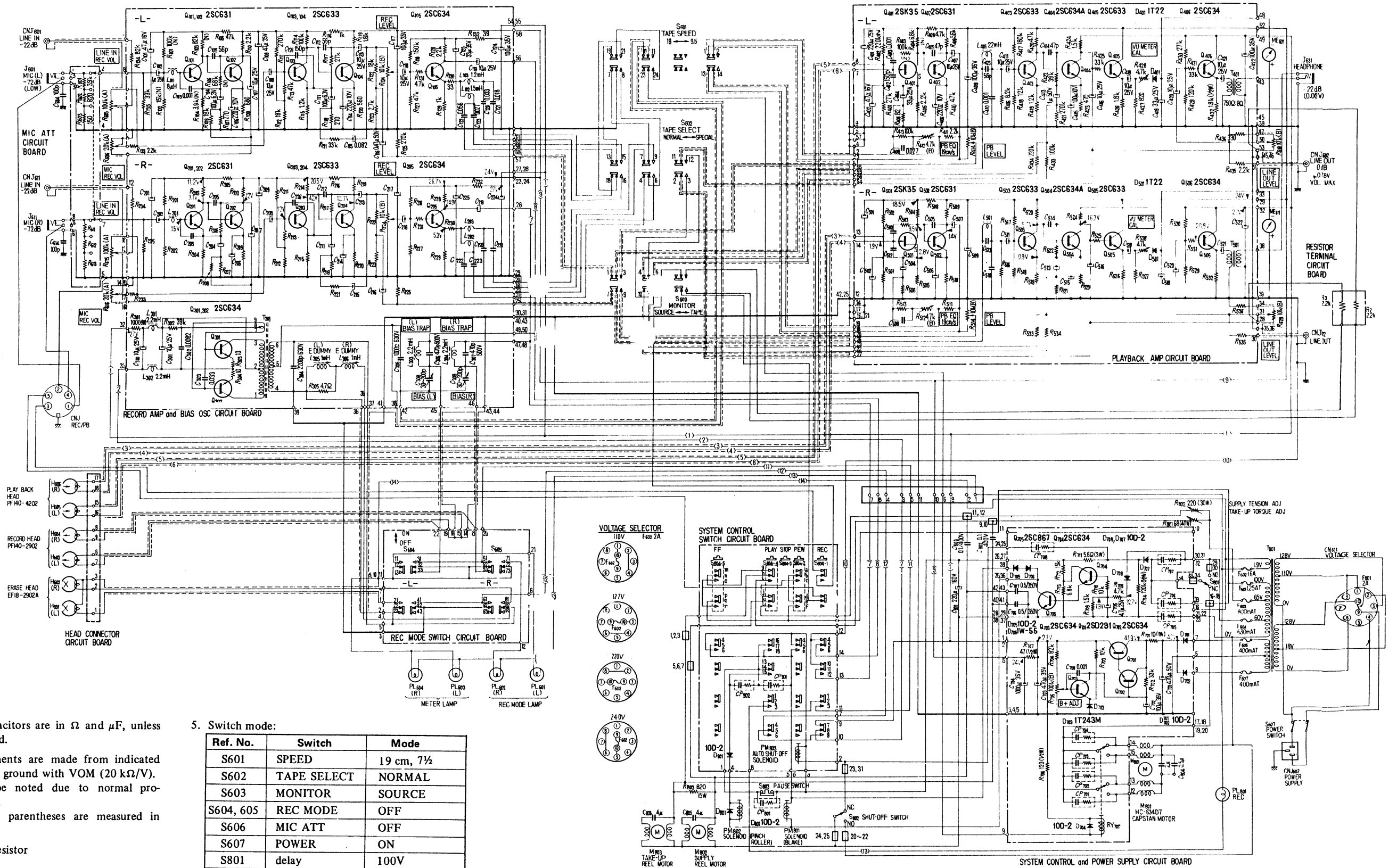

- Note:**
- Resistors and capacitors are in  $\Omega$  and  $\mu F$ , unless otherwise indicated.
  - Voltage measurements are made from indicated points to common ground with VOM (20 k $\Omega$ /V). Variations may be noted due to normal production tolerances. Voltage values in parentheses are measured in record mode.
  - (N): low noise resistor
  - |  |                           |
|--|---------------------------|
|  | AC terminal circuit board |
|--|---------------------------|

5. Switch mode:

Ref. No.	Switch	Mode
S601	SPEED	19 cm, 7½
S602	TAPE SELECT	NORMAL
S603	MONITOR	SOURCE
S604, 605	REC MODE	OFF
S606	MIC ATT	OFF
S607	POWER	ON
S801	delay	100V
S802	shut-off	ON
S803	PAUSE	ON
S804	function	OFF

- Conductor Side -

4-3. MOUNTING DIAGRAM

Transistor Location

- Q101 3D
- Q102 3D
- Q103 3E
- Q104 3E
- Q105 3F

- Q201 4D
- Q202 4D
- Q203 4E
- Q204 4E
- Q205 4F

- Q301 4G
- Q302 4G

- Q401 3M
- Q402 3M
- Q403 3O
- Q404 3O
- Q405 3P
- Q406 2P

- Q501 4M
- Q502 4M
- Q503 4O
- Q504 4O
- Q505 4P
- Q506 5P

- Q101, 201 } 2SC631A
- Q102, 202 } 2SC631A
- Q402, 502 } 2SC631A

- Q103, 203 } 2SC633A
- Q104, 204 } 2SC633A
- Q403, 503 } 2SC633A
- Q405, 505 } 2SC633A

- Q105, 205 } 2SC634A
- Q301, 302 } 2SC634A
- Q404, 504 } 2SC634A
- Q406, 506 } 2SC634A

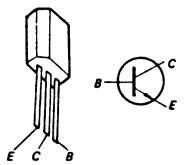

- Q401, 501 2SK35

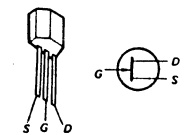

- D401, 501 1T22

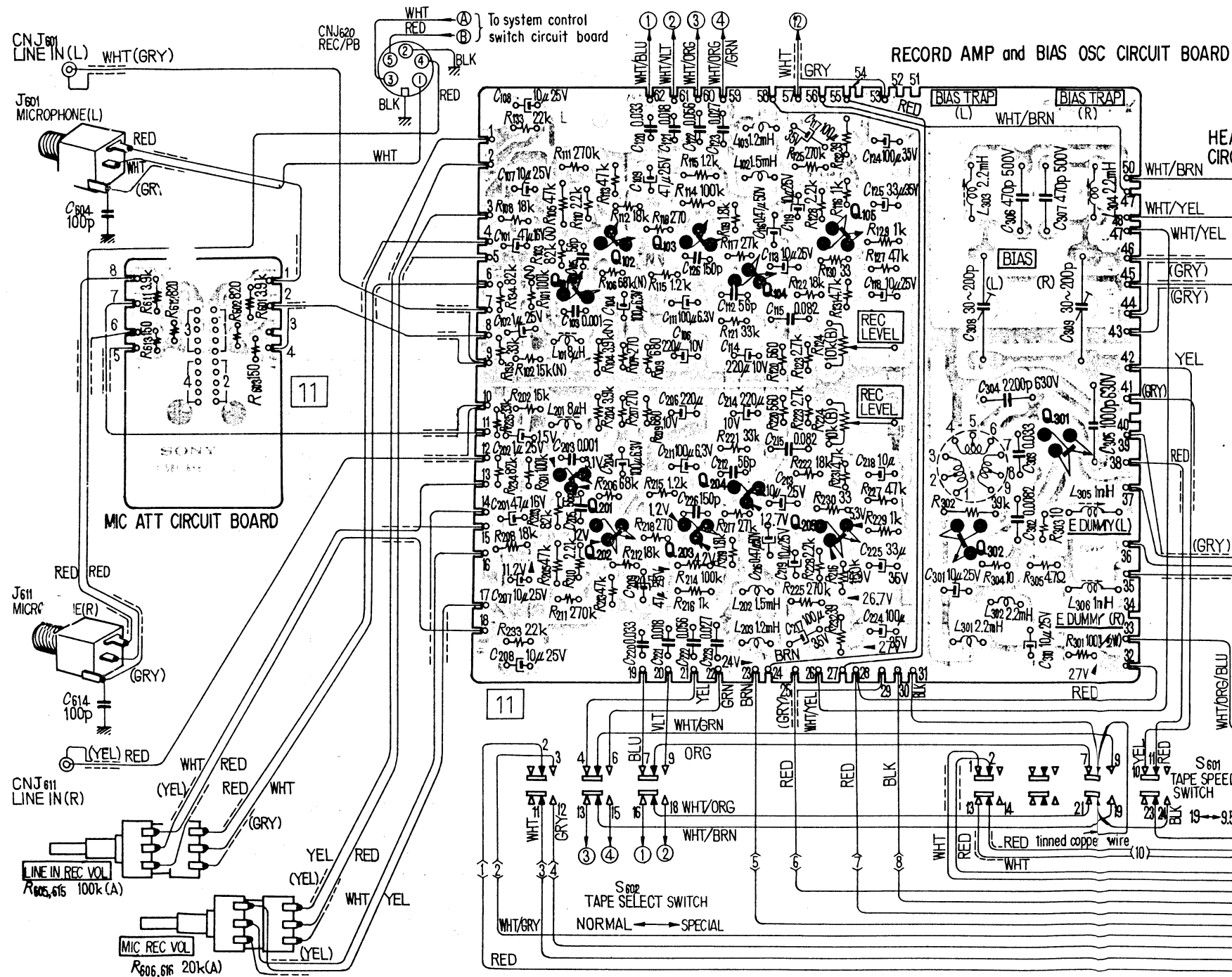
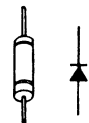



# TC-640A TC-640A

## RD AMP and BIAS OSC CIRCUIT BOARD

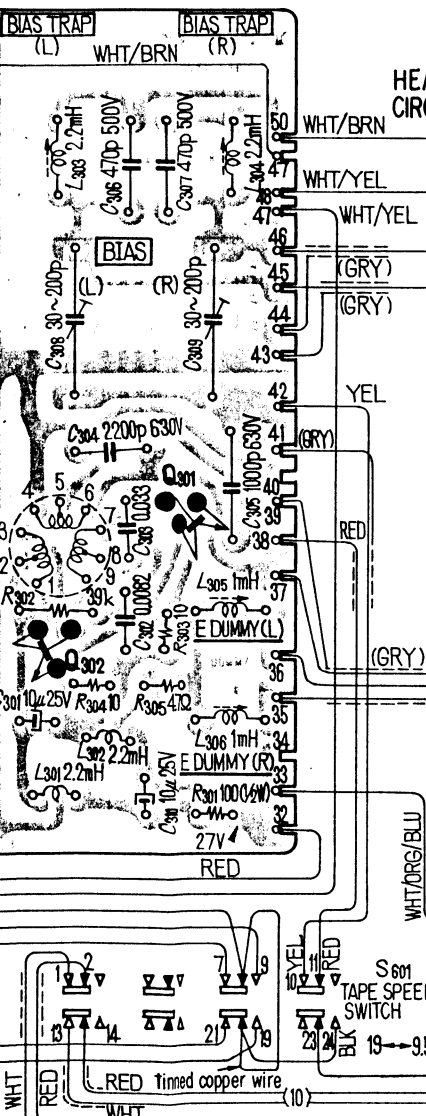

## HEAD CONNECTOR CIRCUIT BOARD

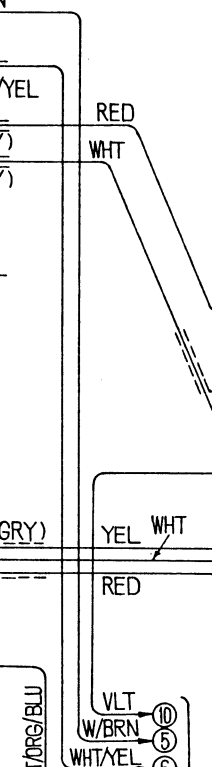

PLAY PF140-4202  
H606 (R) H605 (L)

REC RF140-2902  
H604 (R) H603 (L)

E EF 12 -2902A2  
H602 (R) H601 (L)

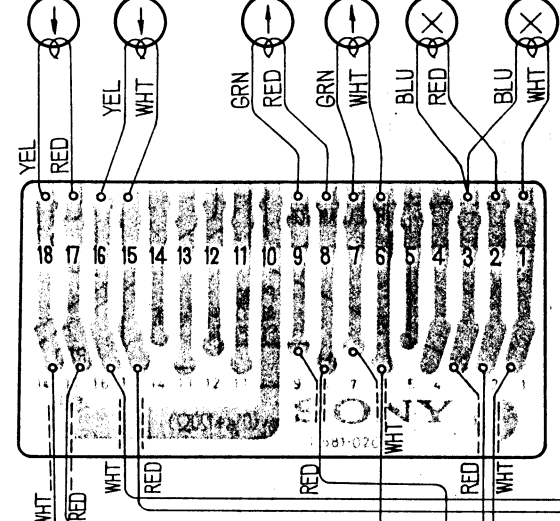

## REC MODE CIRCUIT BOARD

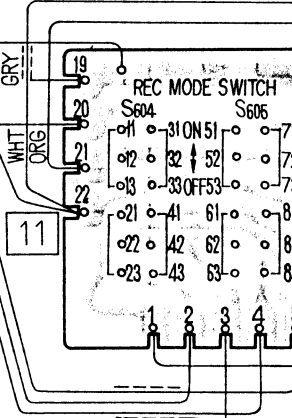

## REC MODE CIRCUIT BOARD

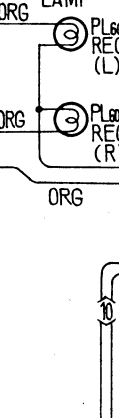

## REC MODE CIRCUIT BOARD

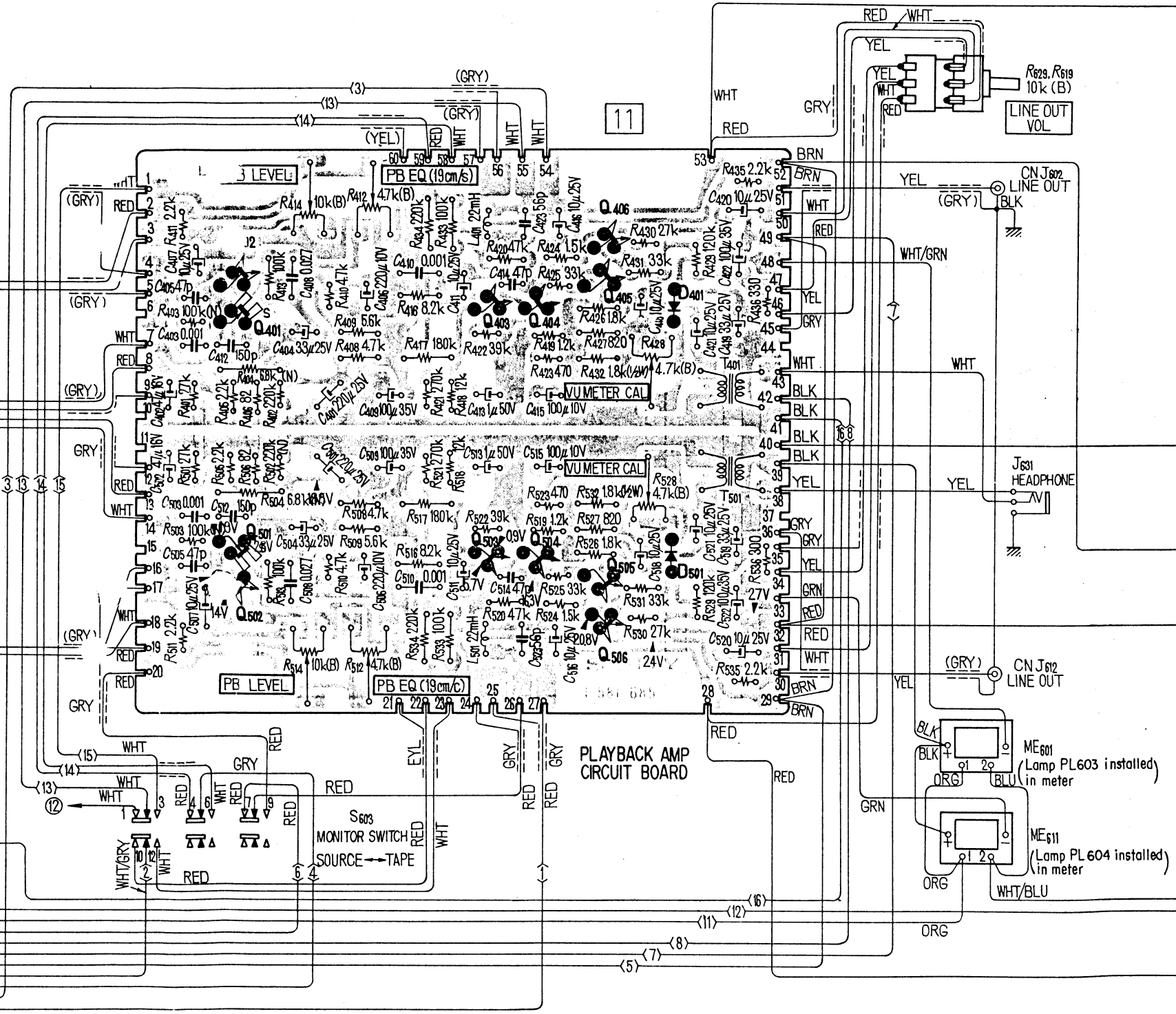
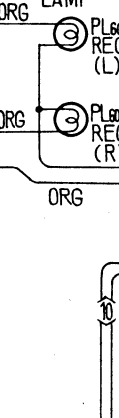

## PLAYBACK AMP CIRCUIT BOARD

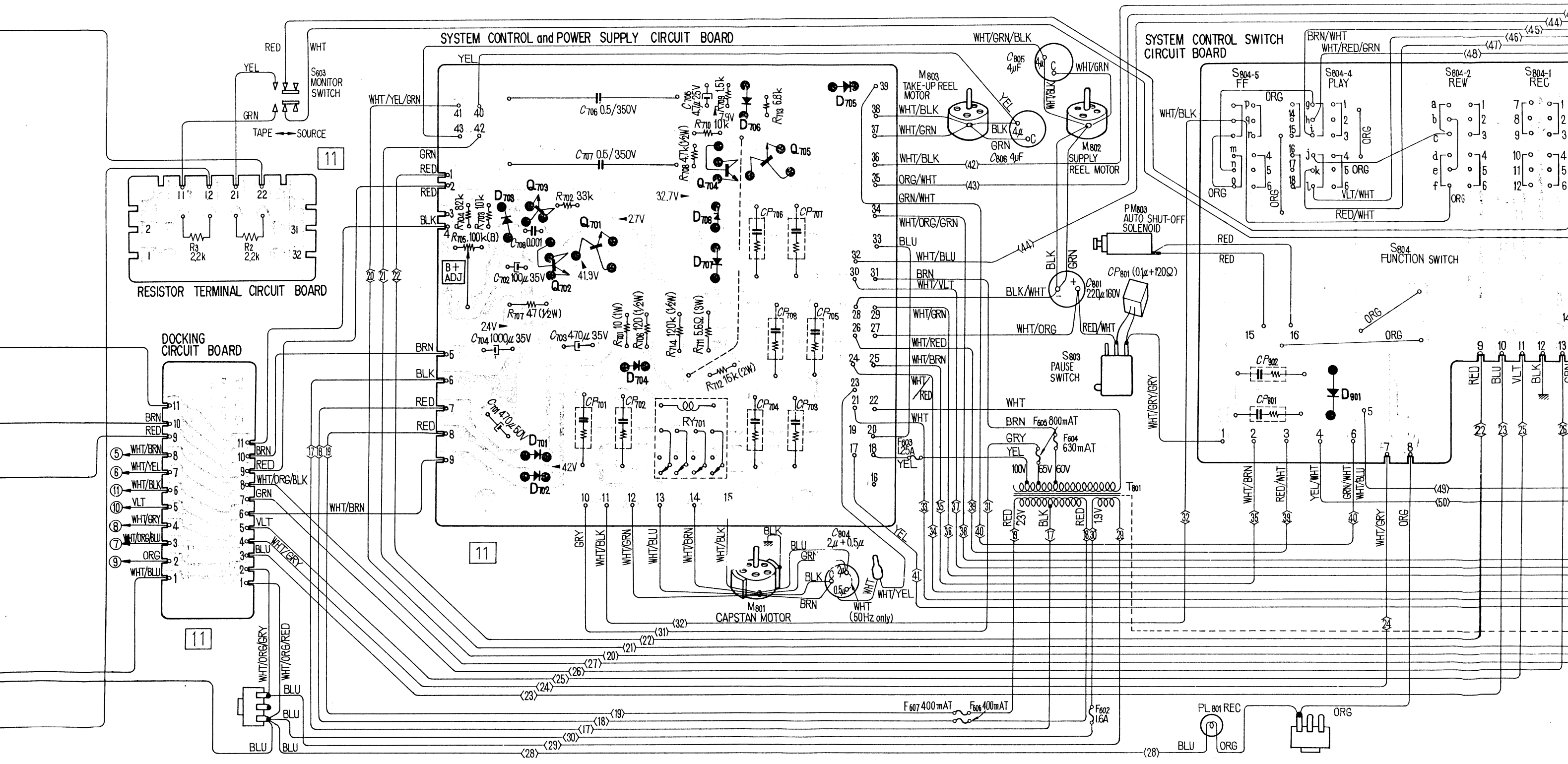

# TC-640A TC-640A

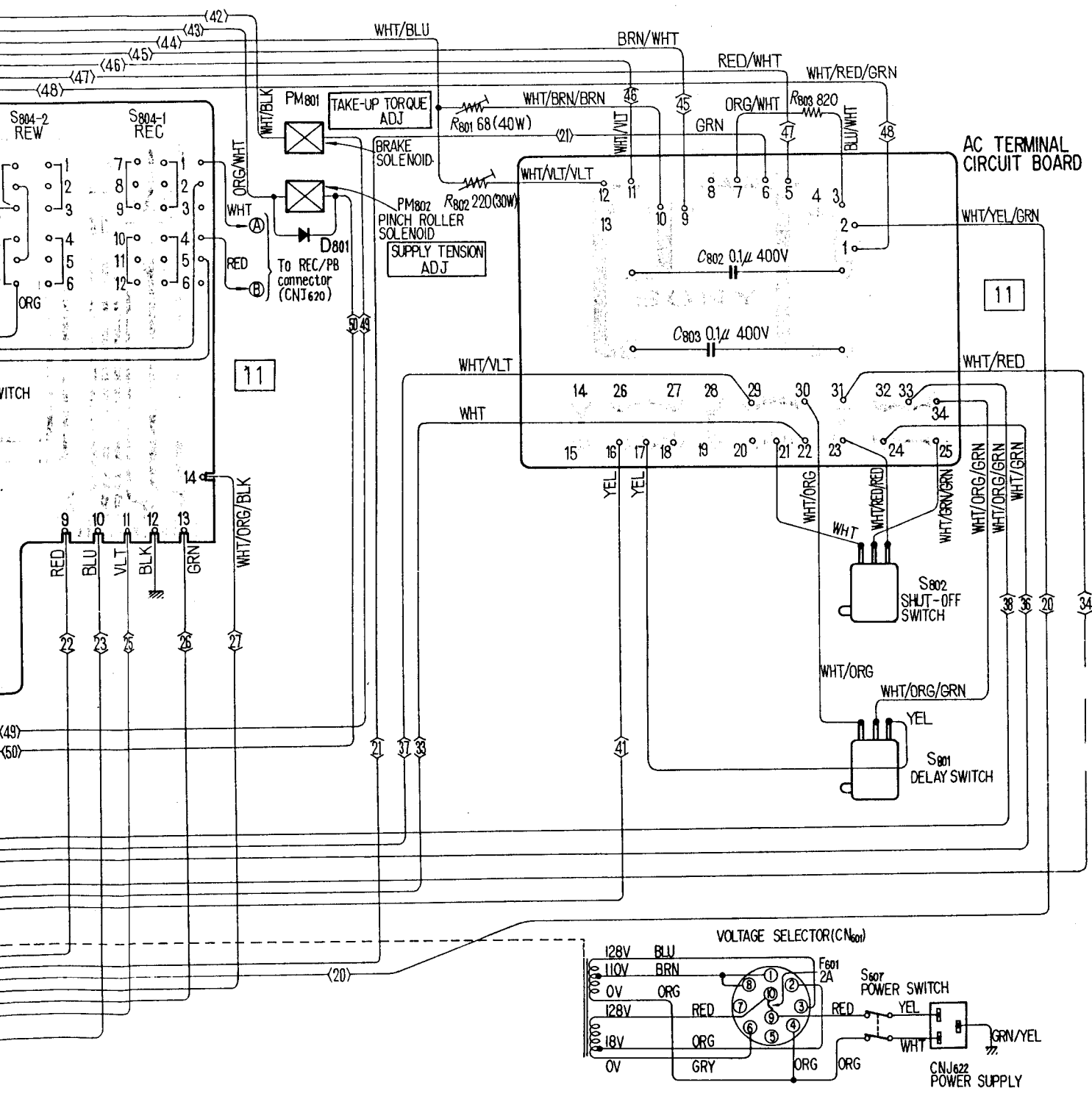

Transistor Location

Q701	3E
Q702	3D
Q703	2D
Q704	2F
Q705	2F

Q701 2SD291

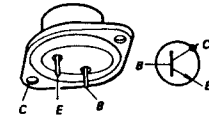

Q702, 703 } 2SC634A  
Q704 }

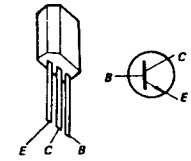

Q705 2SC867

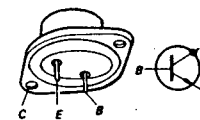

Q701, 702 } 10D-2  
Q704, 705 }  
Q707, 708 }  
Q801, 901 }

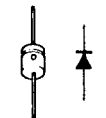

D703 1T243

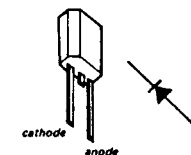

D706 SK-1W55

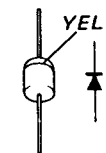

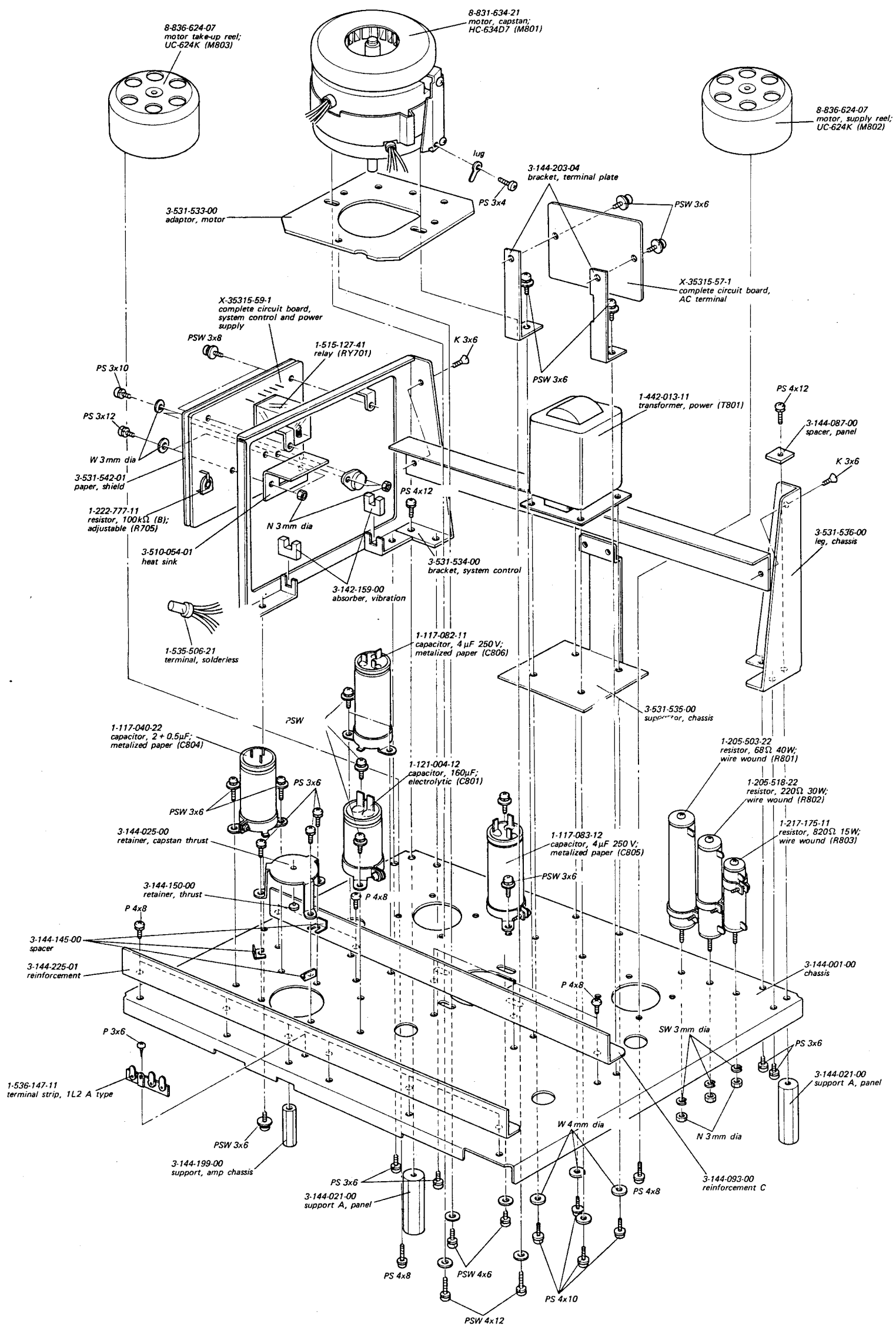

TC-640A TC-640A

- Note:**
1. Parts without part numbers and names are not available.
  2. All screws are Phillips type (cross recess type) unless otherwise indicated.  
(-): slotted head

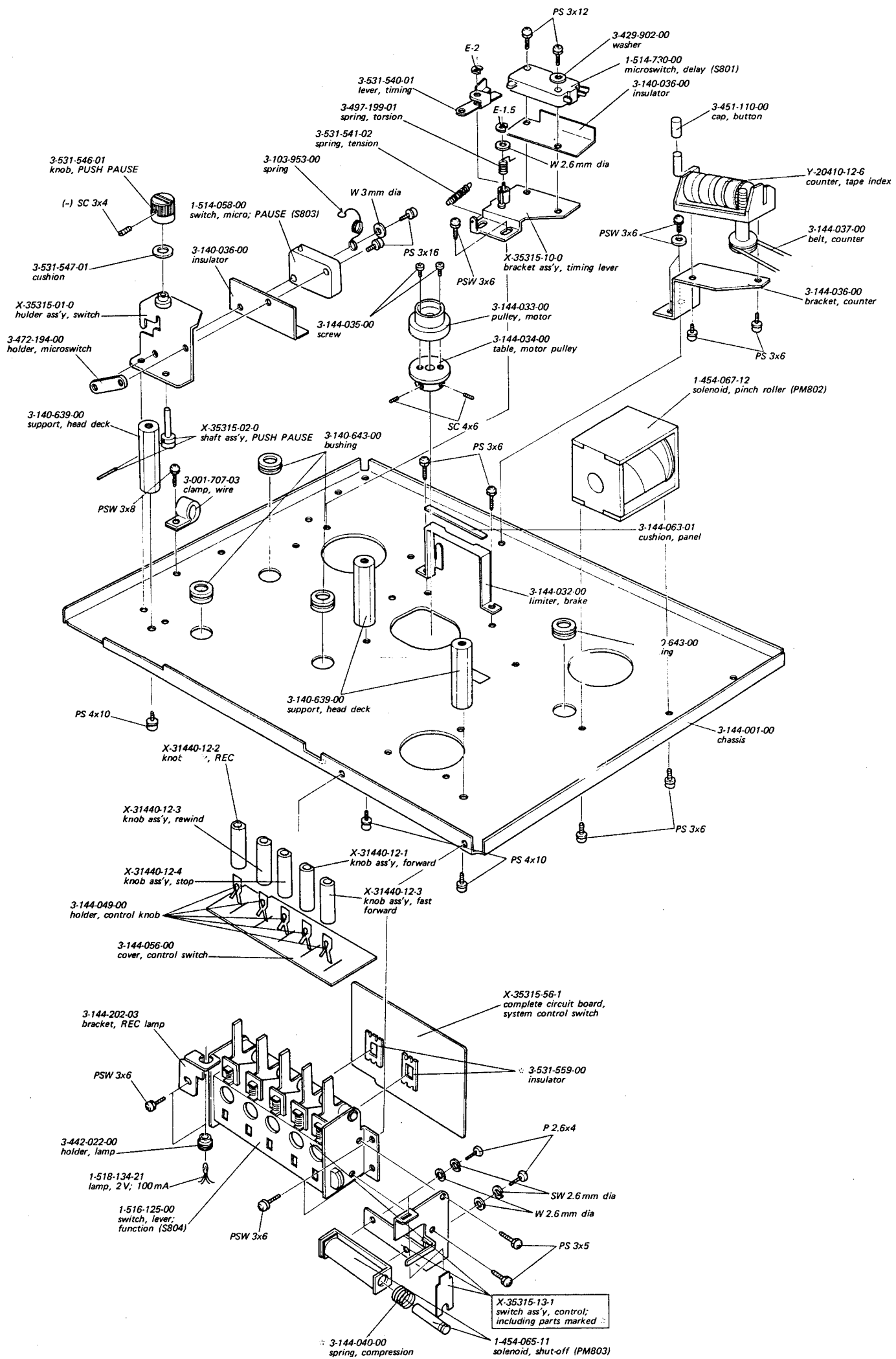

**Note:** 1. Parts without part numbers and names are not available.  
 2. All screws are Phillips type (cross recess type) unless otherwise indicated.  
 (-): slotted head

TC-640A TC-640A

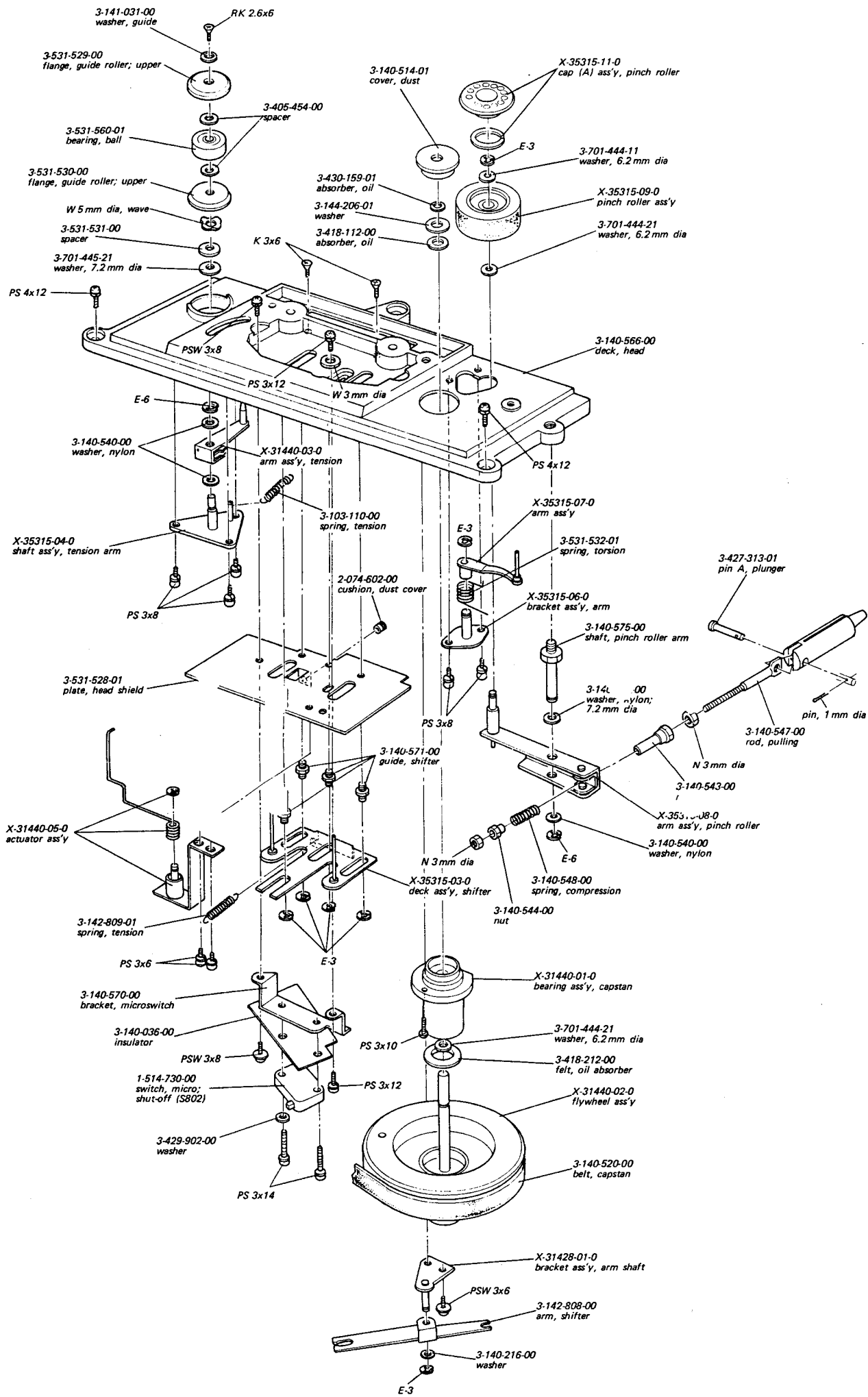

TC-640A TC-640A

- Note:** 1. Parts without part numbers and names are not available.  
 2. All screws are Phillips type (cross recess type) unless otherwise indicated.  
 (-): slotted head

5-8. HEAD DECK (2)

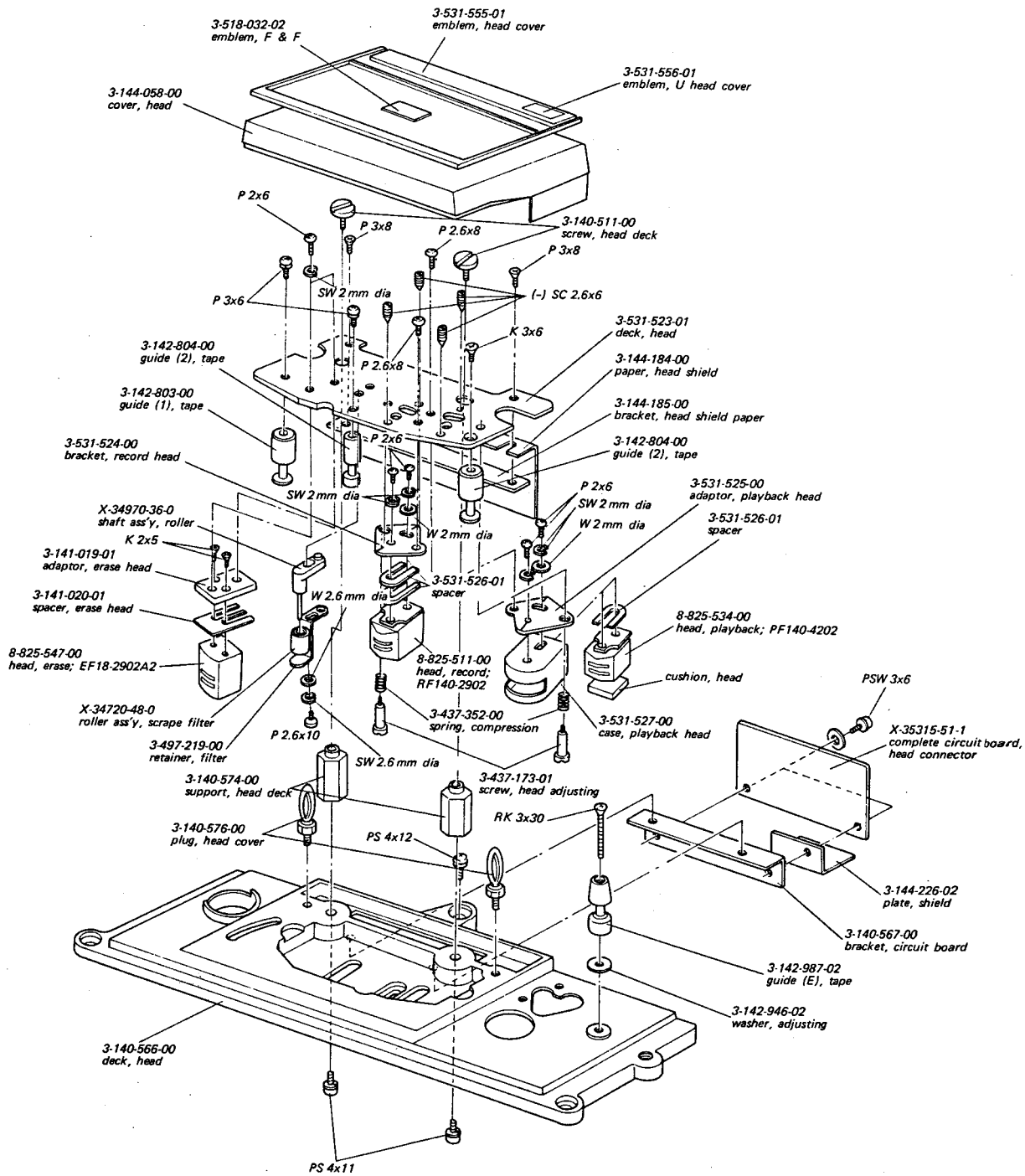

Note: 1. Parts without part numbers and names are not available.  
 2. All screws are Phillips type (cross recess type) unless otherwise indicated.  
 (-): slotted head